



# L16

## Quectel GNSS Engine

### **EVB User Guide**

L16\_EVB\_UGD\_V1.0



<b>Document Title</b>	L16 EVB User Guide
<b>Version</b>	1.0
<b>Date</b>	2012-07-18
<b>Status</b>	Released
<b>Document Control ID</b>	L16_EVB_UGD_V1.0

### **General Notes**

Quectel offers this information as a service to its customers, to support application and engineering efforts that use the products designed by Quectel. The information provided is based upon requirements specifically provided for customers of Quectel. Quectel has not undertaken any independent search for additional information, relevant to any information that may be in the customer's possession. Furthermore, system validation of this product designed by Quectel within a larger electronic system remains the responsibility of the customer or the customer's system integrator. All specifications supplied herein are subject to change.

### **Copyright**

This document contains proprietary technical information of Quectel Co., Ltd. Copying of this document, distribution to others and communication of the contents thereof, are forbidden without permission. Offenders are liable to the payment of damages. All rights are reserved in the event of a patent grant or registration of a utility model or design. All specifications supplied herein are subject to change without notice at any time.

*Copyright © Quectel Wireless Solutions Co., Ltd. 2012*

## Contents

Contents .....	2
Table Index.....	3
Figure Index .....	4
0. Revision history .....	5
1. Introduction.....	6
1.1. Related documents .....	6
1.2. Terms and abbreviations.....	6
2. EVB Kit introduction .....	7
2.1. EVB top and bottom view .....	7
2.2. EVB accessories .....	8
3. Interface application.....	9
3.1. Power interface.....	9
3.2. UART interface .....	10
3.3. Antenna interface.....	11
3.4. Switches and buttons.....	11
3.5. Operating status LEDs .....	12
3.6. Test points .....	13
4. EVB and accessories.....	15
5. Installing device driver.....	16
6. Firmware upgrade .....	17
6.1 The minimum system requirements .....	17
6.2 Usage.....	17
7. GPS testing tool .....	19

## Table Index

TABLE 1: RELATED DOCUMENTS .....	6
TABLE 2: TERMS AND ABBREVIATIONS .....	6
TABLE 3: PINS OF UART1&UART2 PORT (FEMALE) .....	10
TABLE 4: SWITCHES AND BUTTONS .....	12
TABLE 5: OPERATING STATUS LEDS .....	12
TABLE 6: PINS OF X201 .....	13
TABLE 7: EXPLANATIONS OF NMEA WINDOW .....	20

## Figure Index

FIGURE 1: EVB TOP VIEW .....	7
FIGURE 2: EVB BOTTOM VIEW .....	7
FIGURE 3: EVB ACCESSORIES .....	8
FIGURE 4: POWER INTERFACE .....	9
FIGURE 5: UART INTERFACE .....	10
FIGURE 6: ANTENNA INTERFACE .....	11
FIGURE 7: SWITCHES AND BUTTONS .....	11
FIGURE 8: OPERATING STATUS LEDS .....	12
FIGURE 9: TEST POINTS .....	13
FIGURE 10: EVB AND ACCESSORY EQUIPMENTS WITH SERIAL CABLE .....	15
FIGURE 11: DRIVER INSTALLATION WINDOW .....	16
FIGURE 12: UPGRADE TOOL WINDOW .....	17
FIGURE 13: GPS TESTING TOOL DEVICE CONFIGURATION WINDOW .....	19
FIGURE 14: GPS TESTING TOOL NMEA AND DEBUG WINDOW .....	20
FIGURE 15: GPS TESTING TOOL TESTING CONFIGURATION WINDOW .....	21
FIGURE 16: GPS TESTING TOOL TESTING WINDOW .....	22

## 0. Revision history

Revision	Date	Author	Description of change
1.0	2012-07-13	Tonny WU	Initial

## 1. Introduction

This document defines and specifies the usage of L16 EVB (Evaluation Board). Customer can get useful information about L16 EVB and GNSS demo tool from this document.

### 1.1. Related documents

**Table 1: Related documents**

SN	Document name	Remark
[1]	L16_HD	L16 Hardware Design
[2]	L16_Reference_Design	L16 Reference Design
[3]	L16_GNSS_Protocol	L16 GNSS Protocol Specification

### 1.2. Terms and abbreviations

**Table 2: Terms and abbreviations**

Abbreviation	Description
bps	bits per second
CNR	Carrier-to-Noise Ratio
GPS	Global Positioning System
GLONASS	Global Navigation Satellite System (The Russian GNSS)
GNSS	Global Navigation Satellite System
PPS	Pulse Per Second
PRN	Pseudorandom Noise
UART	Universal Asynchronous Receiver & Transmitter
USB	Universal Serial Bus
UTC	Universal Time Coordinated
WGS84	World Geodetic System 1984

## 2. EVB Kit introduction

### 2.1. EVB top and bottom view

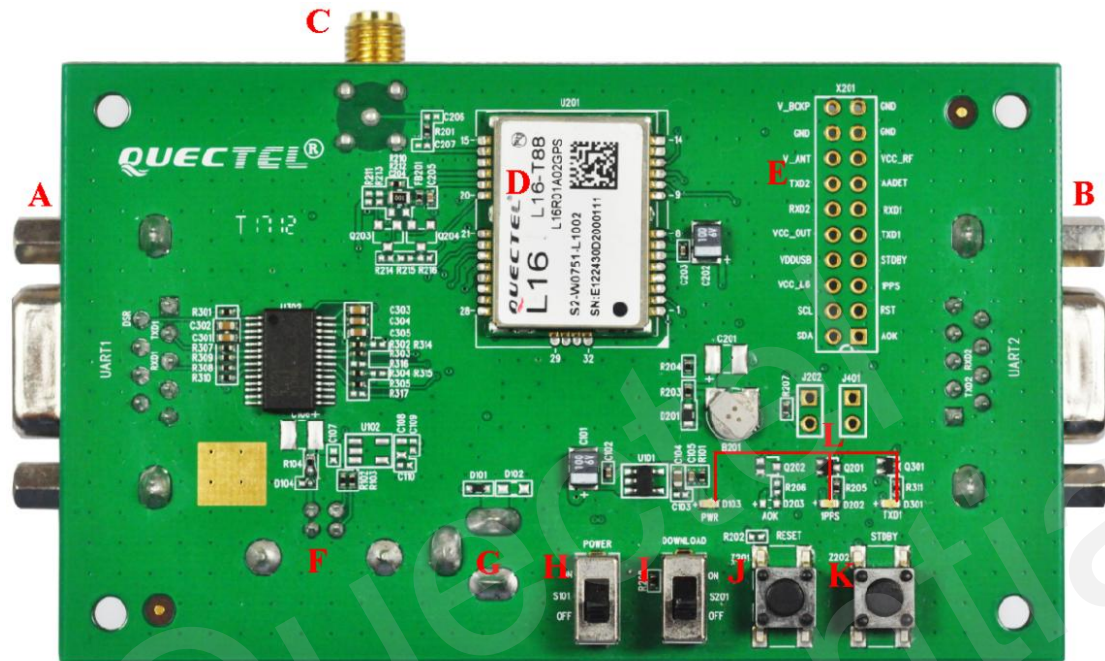

Figure 1: EVB top view

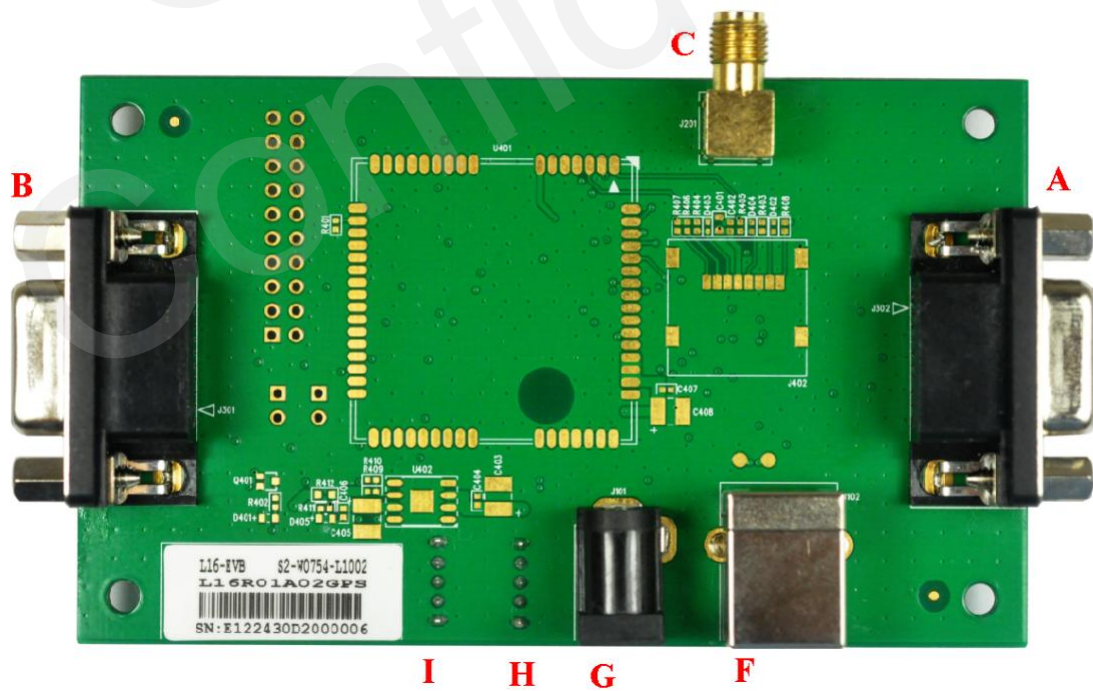

Figure 2: EVB bottom view



- A: UART1 port (NMEA messages port)
- B: UART2 port (Debug messages port)
- C: Antenna interface
- D: L16 Module
- E: Test points
- F: USB interface (not used)
- G: Adapter interface
- H: POWER switch
- I: DOWNLOAD switch
- J: RESET button (not used)
- K: STANDBY button (not used)
- L: Indicated LEDs

## 2.2. EVB accessories



**Figure 3: EVB accessories**

- A: Dedicated GPS/GLONASS active antenna (3.3V)
- B: DC5V/2A power adapter
- C: USB to RS232 converter cable
- D: CD (Device Driver for USB to RS232 converter cable)

### 3. Interface application

#### 3.1. Power interface

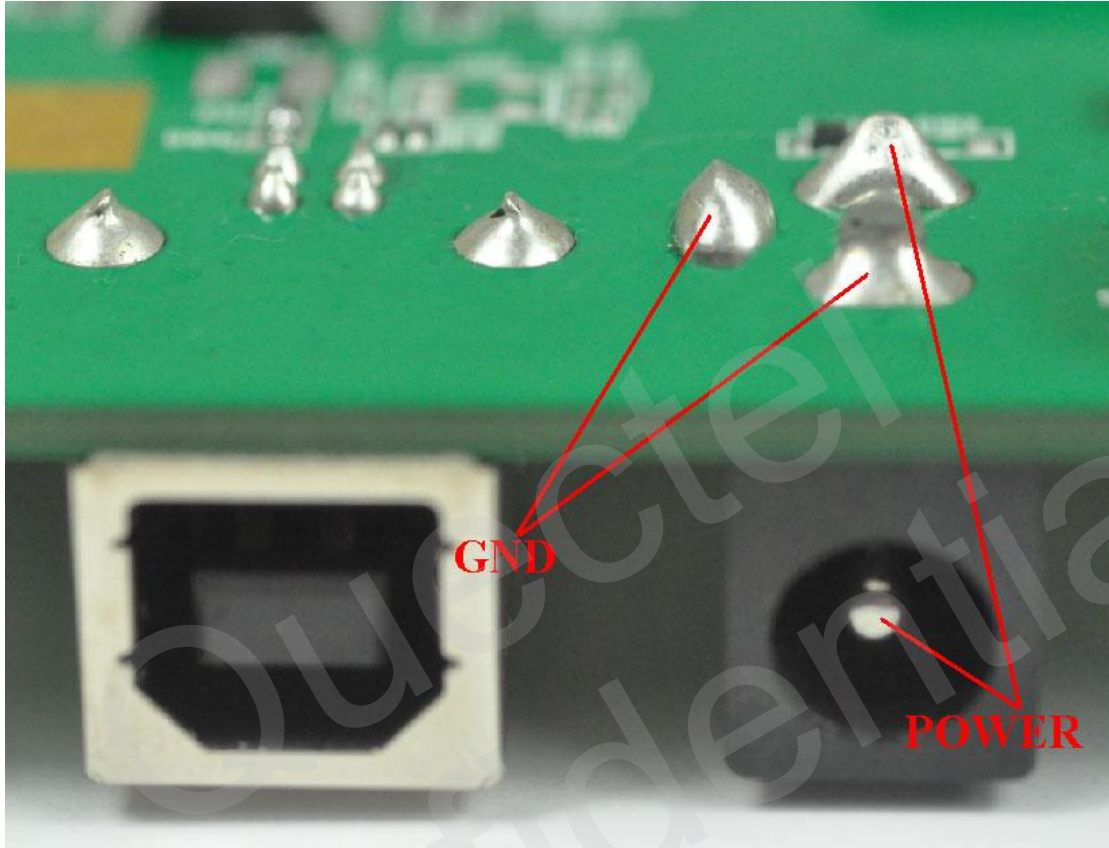

Figure 4: Power interface

### 3.2. UART interface

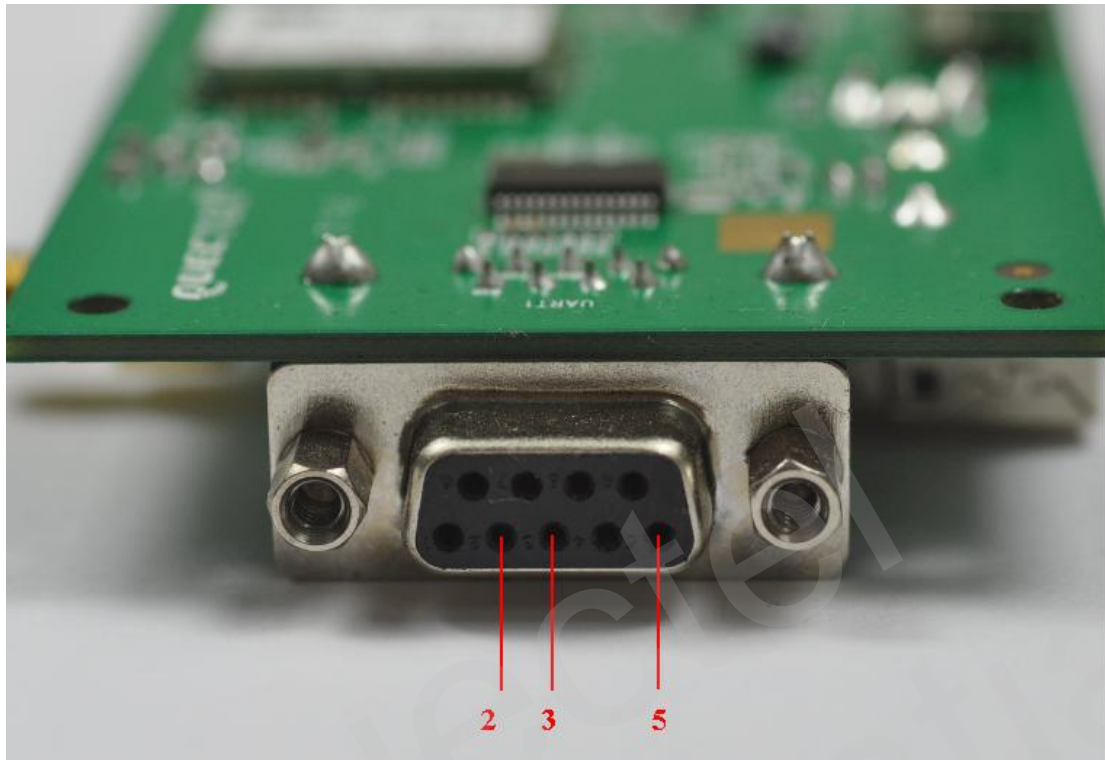

Figure 5: UART interface

Table 3: Pins of UART1&UART2 port (female)

Pin	Signal	I/O	Description
2	TXD	O	Transmit data
3	RXD	I	Receive data
5	GND		GND

*Note: The above pins are RS232 voltage level.*

### 3.3. Antenna interface



Figure 6: Antenna interface

### 3.4. Switches and buttons

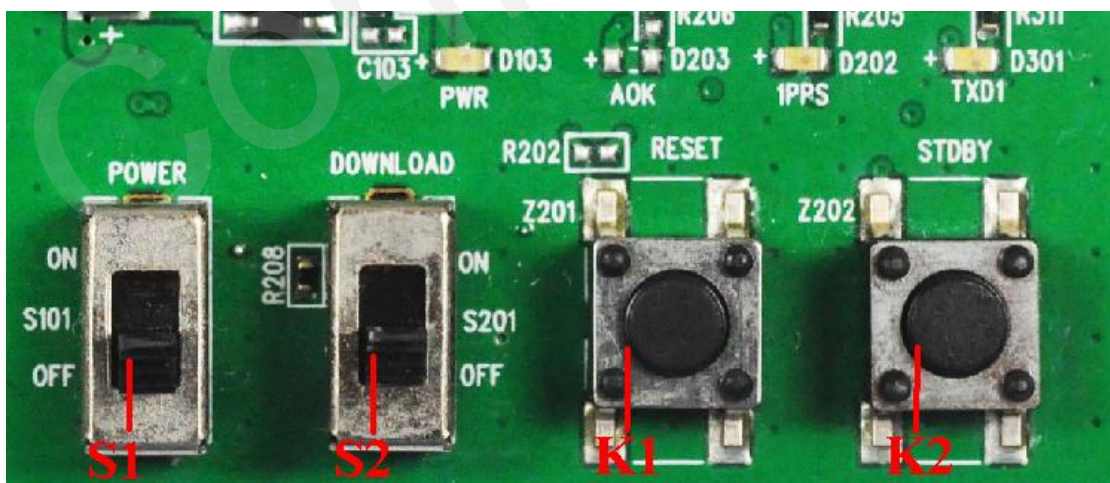

Figure 7: Switches and buttons

Table 4: Switches and buttons

Part	Name	Description
S1	POWER	Switch on to supply power for L16 EVB
S2	DOWNLOAD	Switch on to enter upgrading mode
K1	RESET	Not used
K2	STDBY	Not used

### 3.5. Operating status LEDs

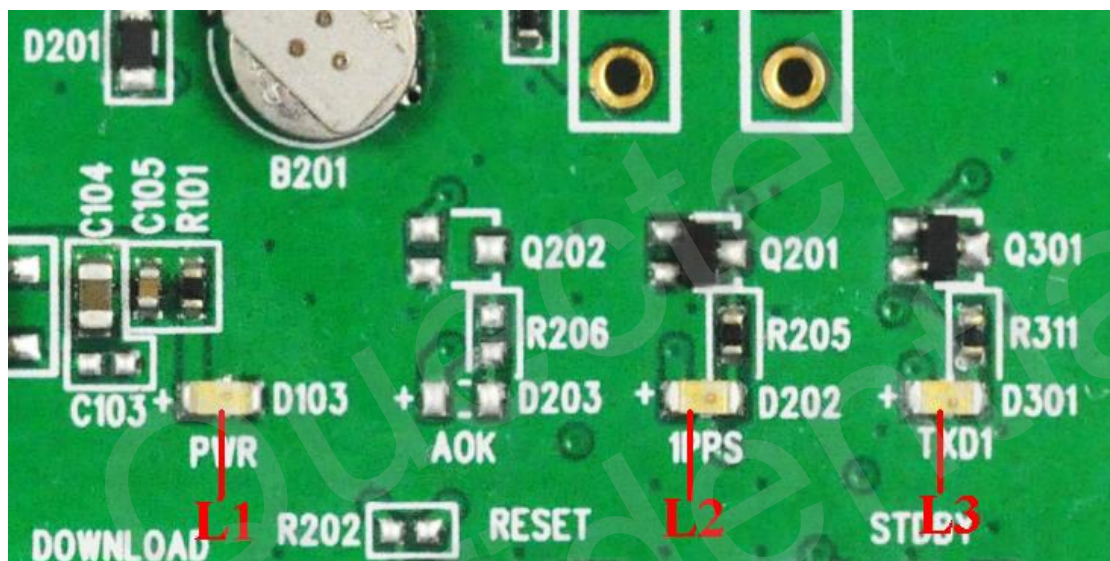

Figure 8: Operating status LEDs

Table 5: Operating status LEDs

Part	Name	Description
L1	PWR	Bright: Power on Extinct: Power off
L2	1PPS	This LED will blink at 1Hz when L16 works normally.
L3	TXD1	This LED will blink when L16's UART1 port outputs messages

### 3.6. Test points

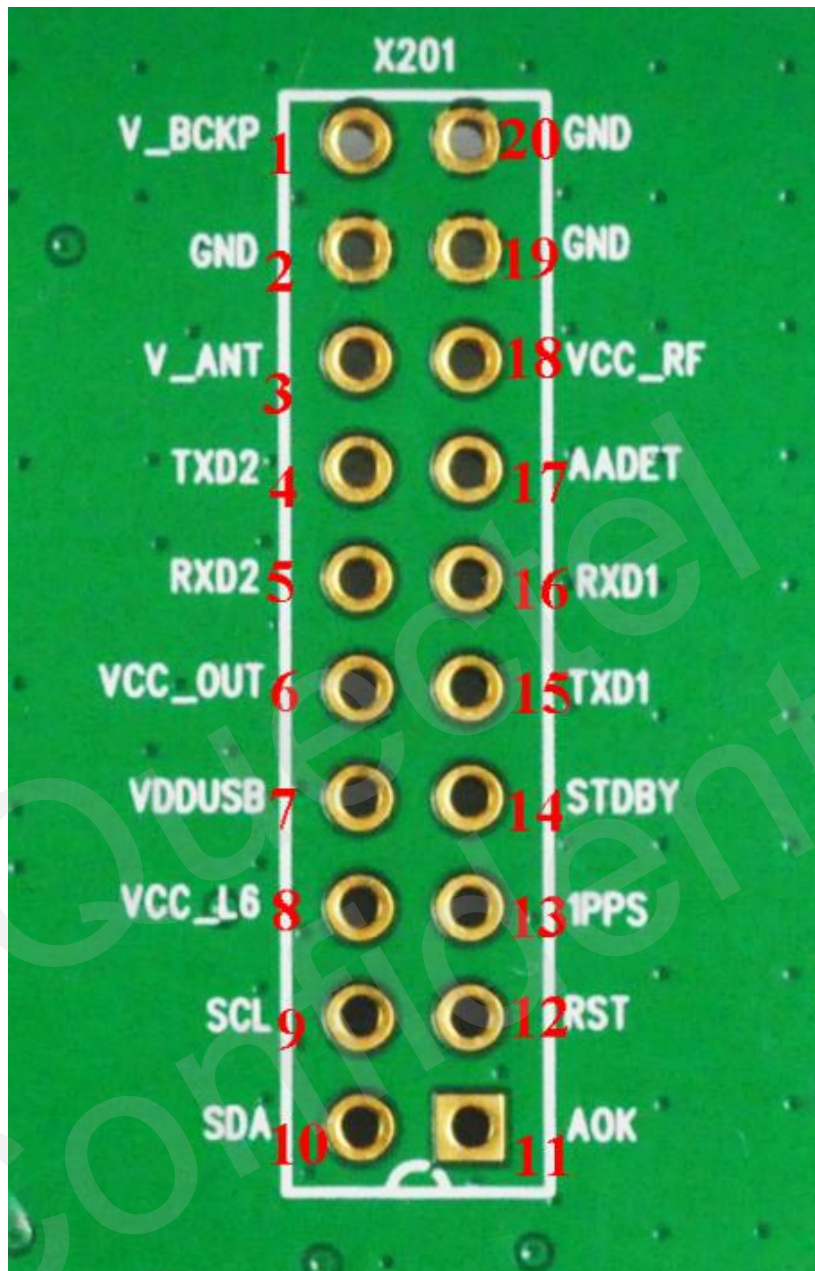

Figure 9: Test points

Table 6: Pins of X201

Pin No.	Signal	I/O	Description
1	V_BCKP	I	Voltage supply for RTC logic
2	GND		Ground
3	V_ANT	I	Voltage supply for external active antenna
4	TXD2	O	Transmit data
5	RXD2	I	Receive data

6	VCC_OUT	O	Voltage output
7	VDDUSB	I	Not used
8	VCC_L6	I	Voltage supply for L16
9	SCL	I/O	Not used
10	SDA	I/O	Not used
11	AOK	O	Not used
12	RST	I	Not used
13	1PPS	O	1 pulse per second
14	STDBY	I	Not used
15	TXD1	O	Transmit data
16	RXD1	I	Receive data
17	AADET	I	Not used
18	VCC_RF	O	Optional output voltage for external active antenna
19	GND		Ground
20	GND		Ground

## 4. EVB and accessories

When USB to RS232 converter cable is used, the EVB and its accessories are equipped as shown in Figure 10.



**Figure 10: EVB and accessory equipments with serial cable**



## 5. Installing device driver

Before using UART port, please install the driver of USB 2.0 to RS232 converter in the attached CD. For detailed information, please refer to the User's Guide as below.



Figure 11: Driver installation window

## 6. Firmware upgrade

Quectel provides X-Loader (1.8) tool for customer to upgrade firmware.

### 6.1 The minimum system requirements

The tool is written in C# using Microsoft Visual Studio 2010 Express and is built with .NET 2.0 Framework. Below are the minimum system requirements:

Windows XP Service Pack 2 or higher;  
.NET 2.0 Framework or higher<sup>123</sup>.

1. [Microsoft .NET Framework Version 2.0 Redistributable Package \(x86\)](#)
2. [Microsoft .NET Framework Version 2.0 Redistributable Package \(x64\)](#)
3. [Microsoft .NET Framework Version 2.0 Redistributable Package \(IA64\)](#)

### 6.2 Usage

Below is the window of TeseoII firmware upgrade tool.

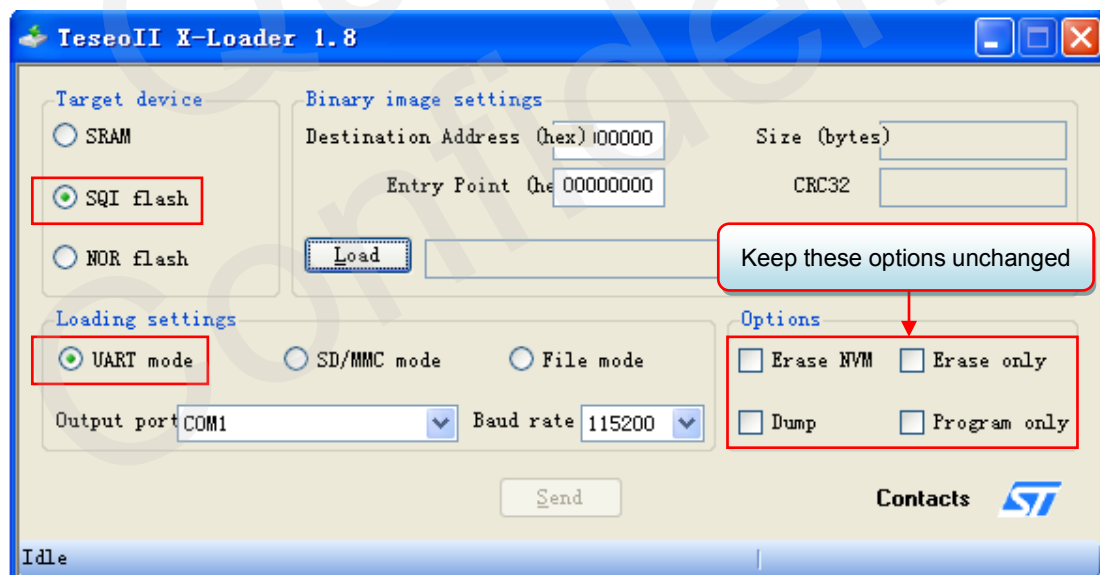

**Figure 12: Upgrade tool window**

Step 1:

In order to upgrade firmware via UART, please connect the UART1 or UART2 port with computer through USB to RS232 converter cable and open the upgrade tool TeseoII X-Loader 1.8.

## Step 2:

- Select “SQI flash” in Target device box and “UART mode” in Loading settings box.
- Click “Load” button to select the firmware file (.bin).
- Click Output port to choose the suitable port number.
- Click Baud rate to choose the suitable upgrade rate, here 921600 is not supported.
- Keep other options unchanged.

## Step 3:

After configuring the above options, turn on DOWNLOAD switch (S2) and repower the system, click “Send” button to start upgrade process.

## Step 4:

Once the upgrade process is finished, turn off S2 and repower the system.

***Note: Switch on S2 to connect 1K resistor between TXD1 net and GND, and switch off S2 to disconnect their connection here.***

## 7. GPS testing tool

The GPS Testing tool can help user to view the status of GNSS receiver conveniently. When the tool is opened, the following window will be displayed:

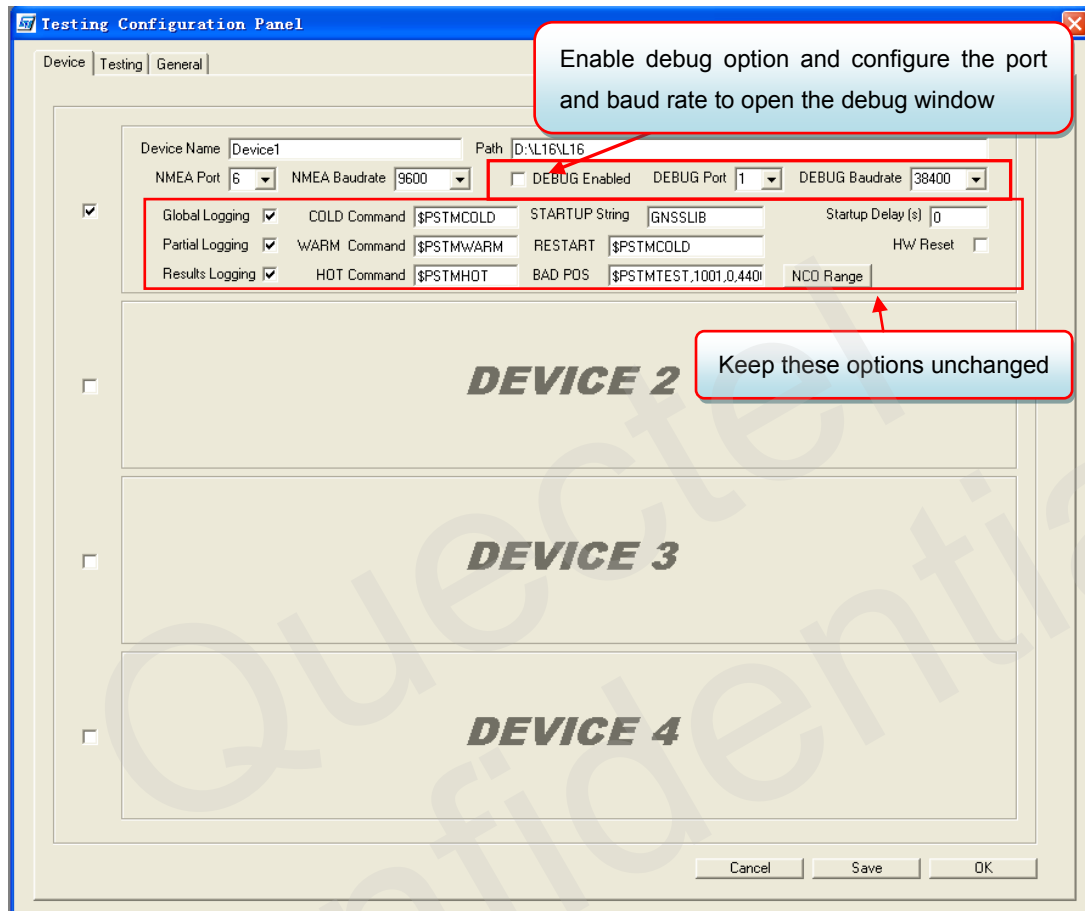

**Figure 13: Device configuration window**

“Device” label:

Input device name and choose path to save the related information. Select suitable NMEA port and baud rate (9600) and keep other options unchanged as shown in the above figure.

Note:

This tool can show the working status of four devices at the same time.

After configuring testing tool, click “Save” to save these configurations and click “OK” to start testing the information of the GNSS signals as below.

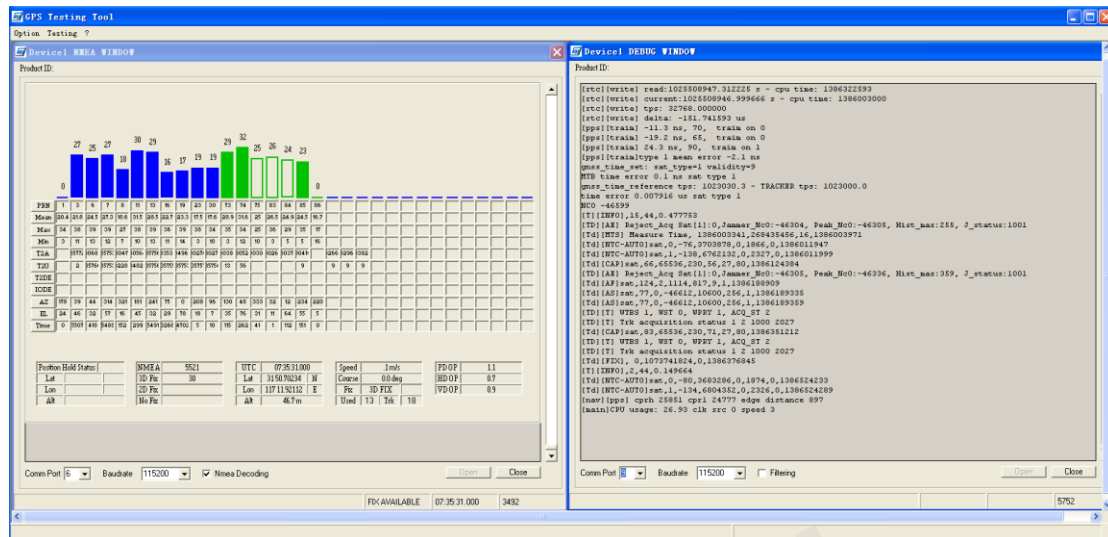

Figure 14: NMEA and debug window

From the NMEA window, customer can find CNR message, time, position, speed and precision information and so on. Explanations are listed in Table 7.

Table 7: Explanations of NMEA window

Icon	Explanation																					
<table border="1"> <tr> <td>UTC</td> <td>09:14:26.000</td> </tr> </table>	UTC	09:14:26.000	UTC time																			
UTC	09:14:26.000																					
<table border="1"> <tr> <td>Lat</td> <td>319.88483</td> <td>N</td> </tr> <tr> <td>Lon</td> <td>12123.55372</td> <td>E</td> </tr> <tr> <td>Alt</td> <td>55.67m</td> <td></td> </tr> <tr> <td>Speed</td> <td>0m/s</td> <td></td> </tr> <tr> <td>Course</td> <td>0.0 deg</td> <td></td> </tr> <tr> <td>Fix</td> <td></td> <td></td> </tr> <tr> <td>Used</td> <td>15</td> <td>Trk 16</td> </tr> </table>	Lat	319.88483	N	Lon	12123.55372	E	Alt	55.67m		Speed	0m/s		Course	0.0 deg		Fix			Used	15	Trk 16	Latitude and longitude degree Altitude based on WGS84 Datum Speed of receiver Satellite numbers
Lat	319.88483	N																				
Lon	12123.55372	E																				
Alt	55.67m																					
Speed	0m/s																					
Course	0.0 deg																					
Fix																						
Used	15	Trk 16																				
<table border="1"> <tr> <td>PDOP</td> <td>1.2</td> </tr> <tr> <td>HDOP</td> <td>0.9</td> </tr> <tr> <td>VDOP</td> <td>0.8</td> </tr> </table>	PDOP	1.2	HDOP	0.9	VDOP	0.8	Position Dilution of Precision Horizontal Dilution of Precision Vertical Dilution of Precision															
PDOP	1.2																					
HDOP	0.9																					
VDOP	0.8																					
<table border="1"> <tr> <td>40</td> <td>41</td> </tr> <tr> <td>21</td> <td>76</td> </tr> </table>	40	41	21	76	The CNR of PRN 21 is 40dB/Hz and the CNR of PRN 76 is 41dB/Hz. Blue for GPS and Green for GLONASS. The filling column means the navigation data of this satellite is in use.																	
40	41																					
21	76																					
<table border="1"> <tr> <td>39</td> <td>21</td> </tr> <tr> <td>30</td> <td>31</td> </tr> </table>	39	21	30	31	The CNR of PRN 30 is 39dB/Hz. White empty column means the navigation data of this satellite is not in use.																	
39	21																					
30	31																					

Customer can open “Command Panel” from “option” menu, and send Peak common commands (such as cold start, warm start and hot start commands) conveniently.

Besides, customer can take more tests automatically with the configuration as below.

Choose “Testing” label, select test types, input test number and delay time, 15~45s delay is recommended here, and keep other options unchanged shown as below.

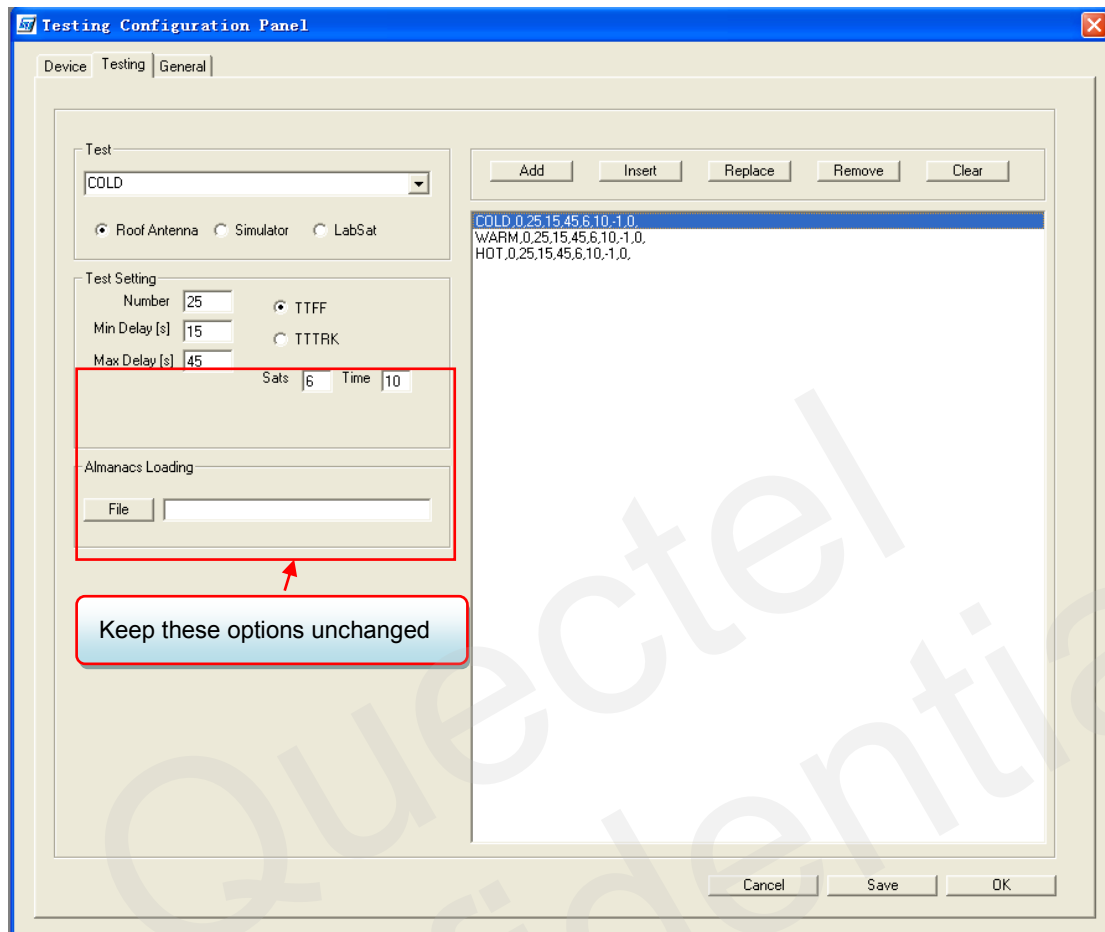

**Figure 15: Testing configuration window**

After configuring these options, click “OK”, and then open “Testing” menu to select “New Test Session”, the test process will display as below, and the related data will be saved in the path (“D:\L16”).

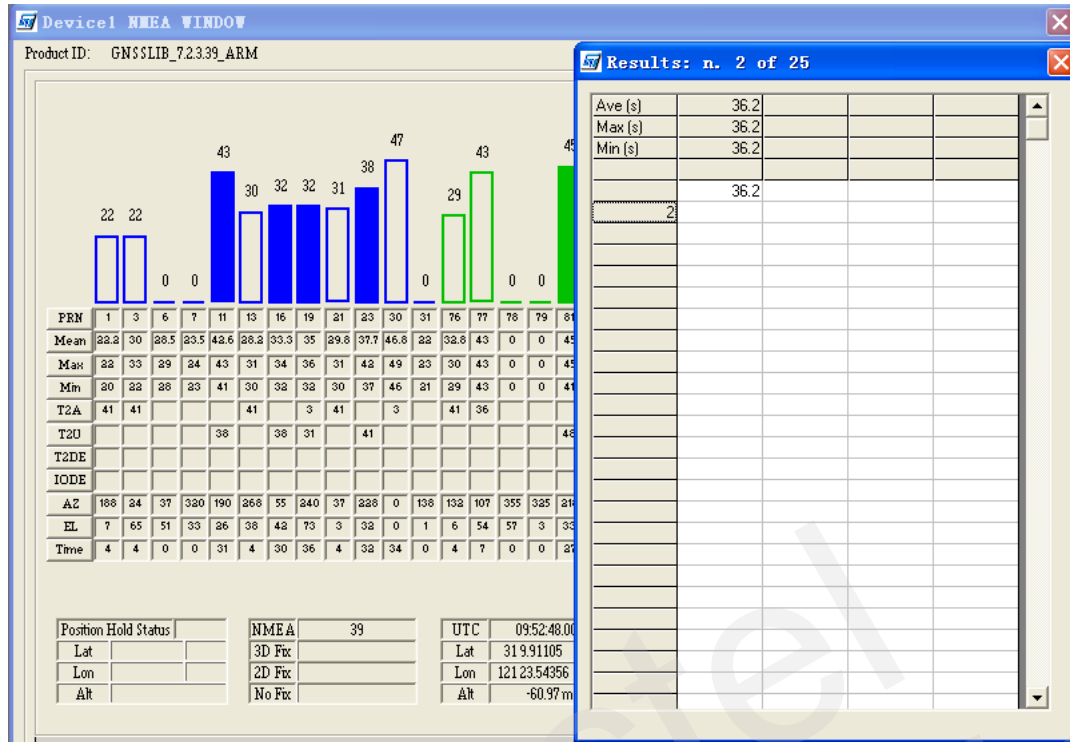

Figure 16: Testing window

# QUECTEL



**Shanghai Quectel Wireless Solutions Co., Ltd.**

**Room 501, Building 13, No.99, TianZhou Road, Shanghai, China 200233**

**Tel: +86 21 5108 6236**

**Mail: [info@quectel.com](mailto:info@quectel.com)**