

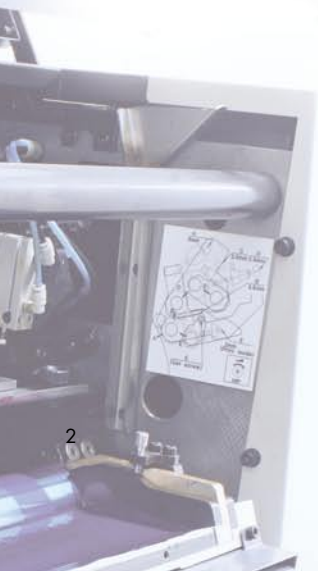

**TOPJOB®**

The Rail-Mounted Terminal Block System

**WAGO®**  
INNOVATIVE CONNECTIONS



# The Industry's Largest Portfolio for Industrial, Building and Transportation Applications

- Industry's widest range of conductor sizes:  
0.14–95 mm<sup>2</sup> (AWG 4/0–24)
- Comprehensive range of through and function  
terminal blocks
- Connect all conductor types

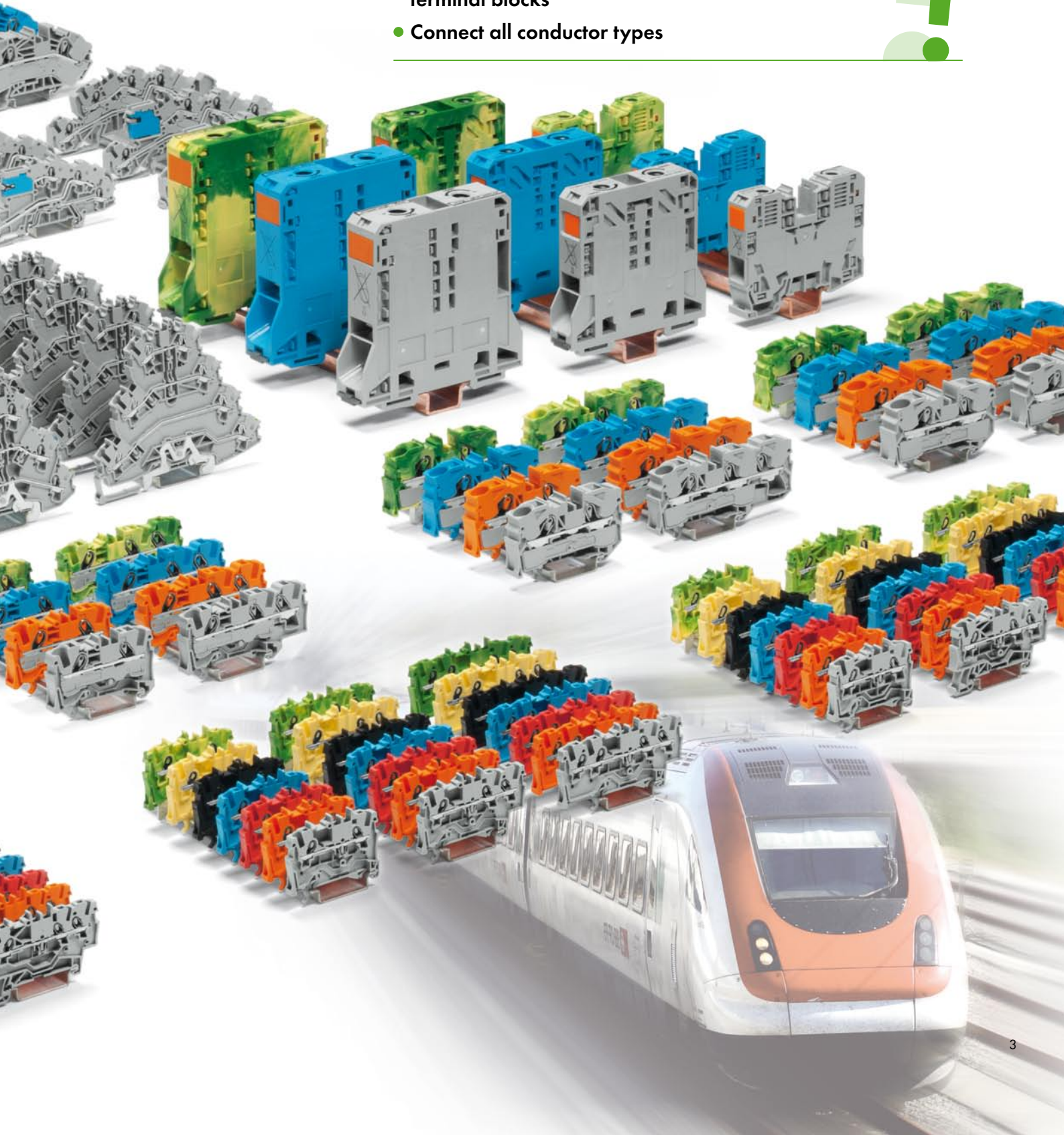

TOPJOB® S – Vibration-Pro

WAGO – The Spring Press

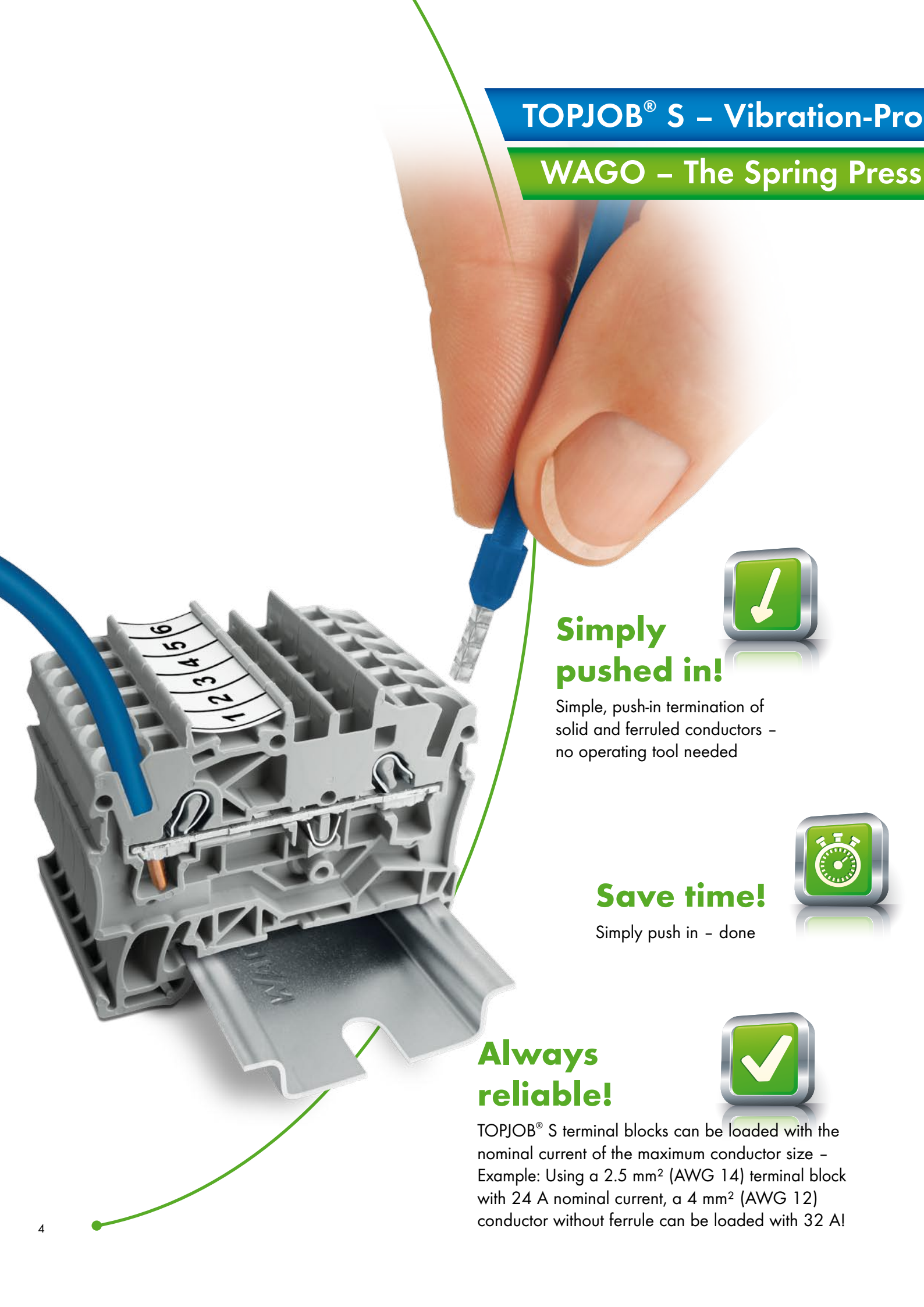

## Simply pushed in!



Simple, push-in termination of solid and ferruled conductors - no operating tool needed

## Save time!



Simply push in - done

## Always reliable!



TOPJOB® S terminal blocks can be loaded with the nominal current of the maximum conductor size - Example: Using a 2.5 mm<sup>2</sup> (AWG 14) terminal block with 24 A nominal current, a 4 mm<sup>2</sup> (AWG 12) conductor without ferrule can be loaded with 32 A!

# of, Fast, Maintenance-Free ure Connection Technology

Expect absolute reliability.

For decades, WAGO has provided components featuring proven, vibration-proof Spring Pressure Termination Technology for demanding railway, transportation and marine applications. Our TOPJOB® S spring clamp also provides the highest levels of long-term stability.

## What does this mean for you?

Top reliability without frequent maintenance.

TOPJOB® S makes wiring as simple as child's play:

The innovative CAGE CLAMP® S connection provides you easy termination of all conductor types!

You are free to choose any type of conductors: solid, stranded, fine-stranded or ferruled!

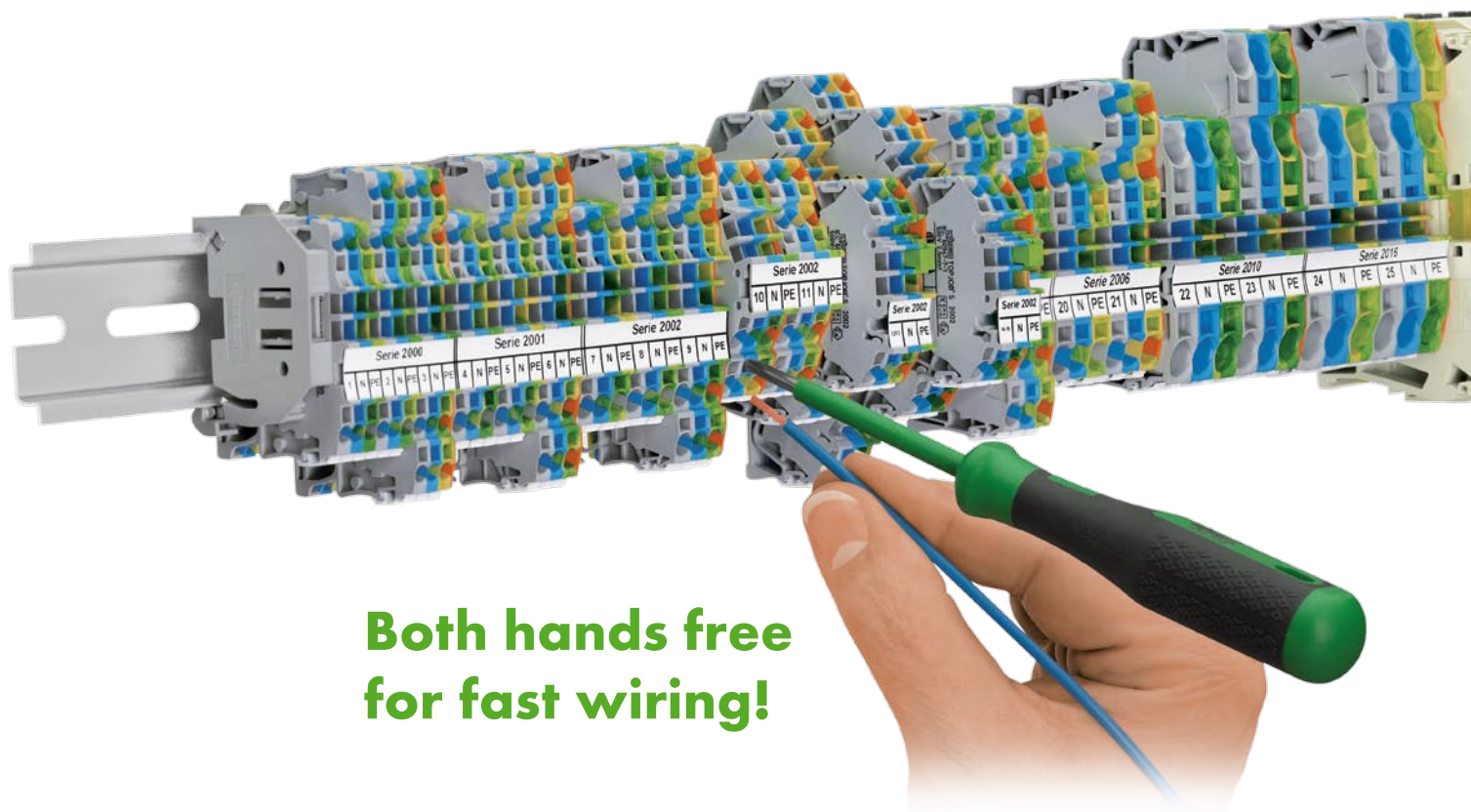

**Both hands free  
for fast wiring!**

- CAGE CLAMP® S for all conductor types
- Simple, push-in termination of solid and ferruled conductors
- The operating tool is captivated, holding the clamping unit open, while the conductor is inserted.

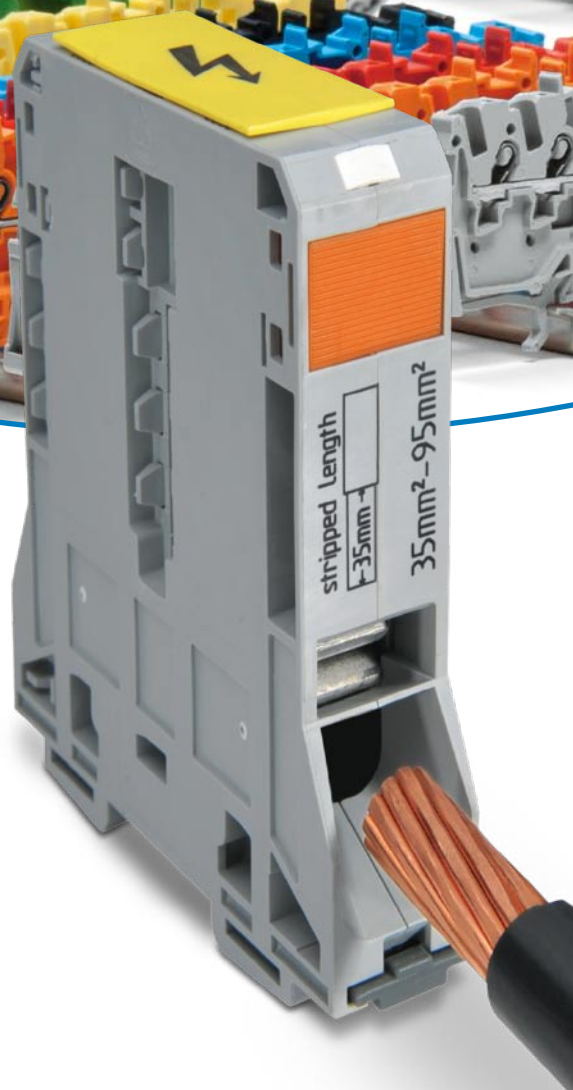

# The Smallest, the Biggest and Always the Right Terminal Blocks

## The Smallest – Just 3.5 mm (0.138 in.) Wide

Minimized blocks maximize cabinet space.

## Up to 1.5 mm<sup>2</sup> (AWG 16) at 18 A!



## The Biggest – Up to 95 mm<sup>2</sup> (AWG 4/0)

Terminate conductors with just one turn:

- 35 mm<sup>2</sup> (AWG 8-2) 1000 V/125 A  
600 V/115 A UR CSA
- 50 mm<sup>2</sup> ((AWG 8-2/0) 1000 V/150 A  
600 V/150 A UR CSA
- 95 mm<sup>2</sup> (AWG 4-4/0) 1000 V/232 A  
600 V UR CSA
- 200 A UR  
210 A CSA

## In Between – At 2.5 mm<sup>2</sup> (AWG 14) Conductor Size Just 4.2 mm (0.165 in.) Terminal Block Width!

- Industry's widest range of spring-clamp terminal blocks
- For conductor sizes 0.14–95 mm<sup>2</sup> (AWG 4/0–24)
- Full 2.5 mm<sup>2</sup> (AWG 14) conductor termination in just 4.2 mm terminal block width

## Typically WAGO –

# The Fastest and Most Efficient Marking System

- Inline marker slots provide fast marking via WMB-Inline markers or marking strips
- Three-line marking strips for clear marking
- Versatile, separable WMB-Inline markers can be used on all marking levels
- Print strips via DYMO 3M PL300 portable printer – for professional, on-site marking with or without software
- Continuous marker strip fits across terminal blocks of different sizes
- Significant time savings and easier identification via multi-line marking
- Reduces marking costs





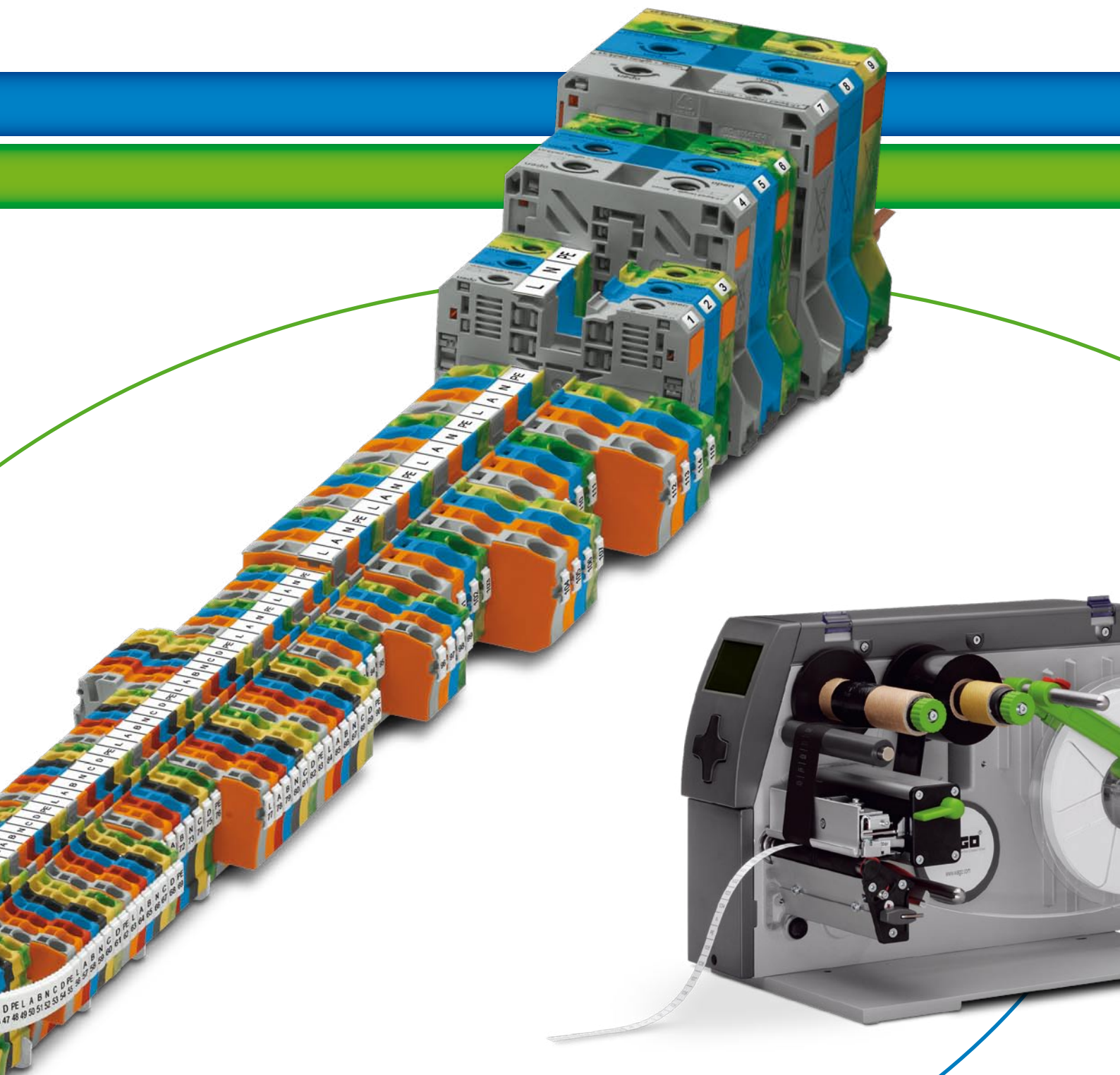

# TOPJOB® S Jumper System

## Ready to Solve Any Commoning Tasks

**WAGO's range of jumpers provide the greatest possibilities and convenience:**

Multi-pole, **push-in type jumper bars** can be customized to suit your specific needs. Tailor jumpers by simply breaking out individual contact lugs!

Need endless potential multiplication in a single jumper slot? With our **adjacent jumpers for continuous commoning**, this is possible – no problems or limits!

Our **step-down jumpers** easily combine conductors of varying sizes.

Using **push-in type wire jumpers**, jumper contacts can be connected with different spacing and heights to your specific requirements.

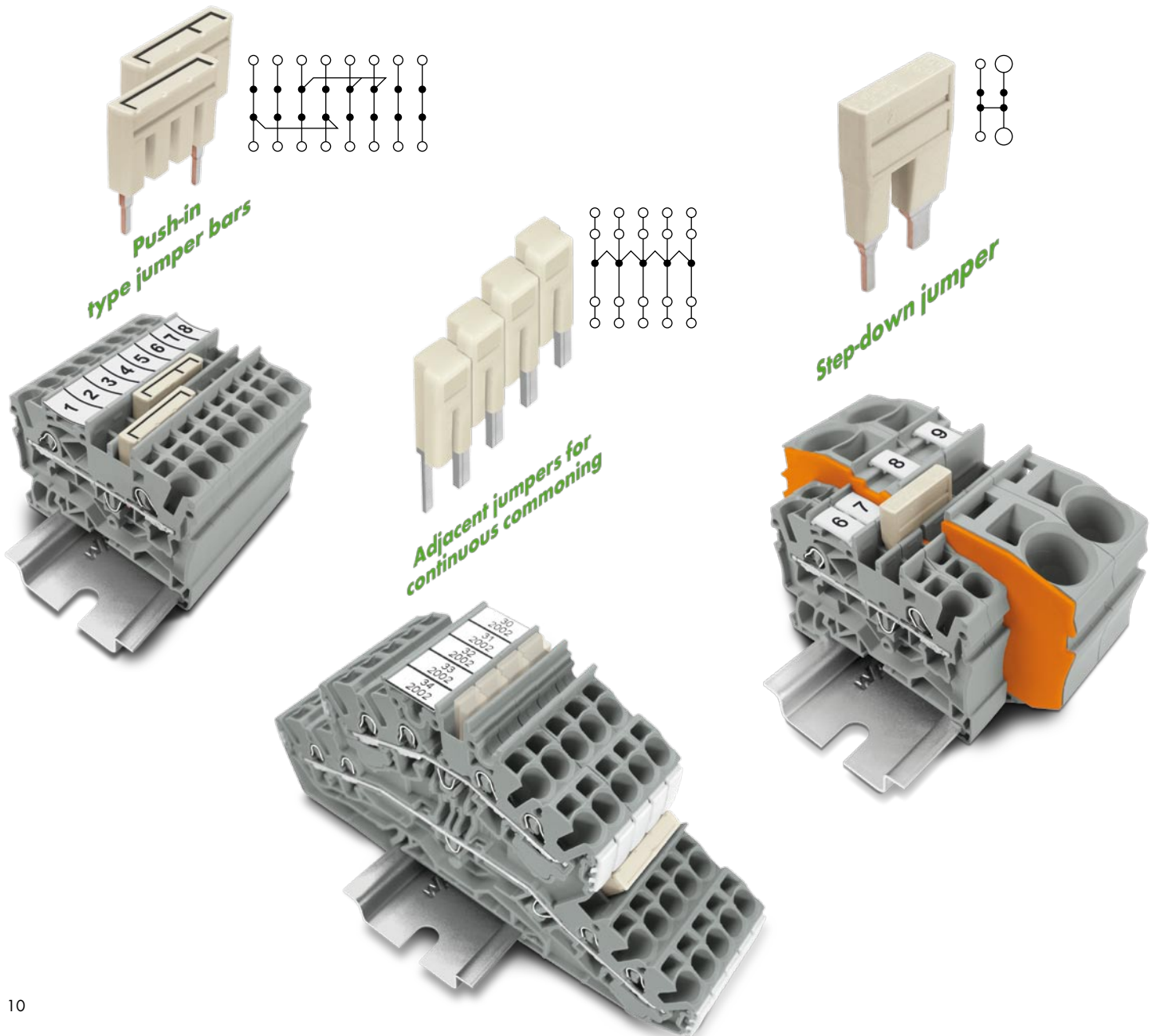

Staggered jumpers **allow you to accommodate different potentials in a single jumper slot along side each other.**

Multi-pole, push-in type jumper bars can be customized to suit your specific needs.

The perfect solution for multilevel terminal blocks: **Vertical jumpers** easily connect two or three levels.

- Comprehensive jumper system for virtually any application
- Custom jumpers can be created
- Simple, easy-to-use design

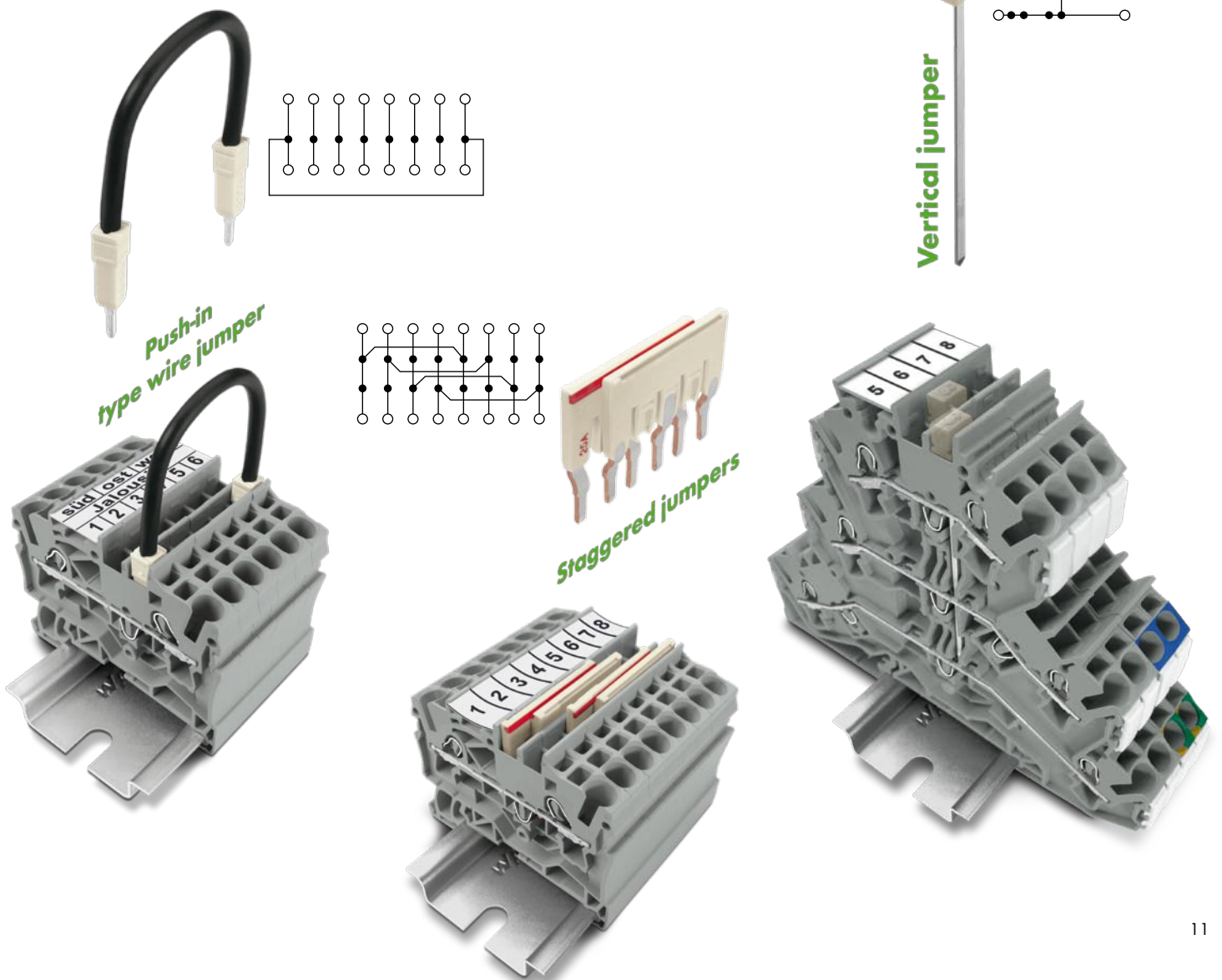

### Pluggable rail-mount terminal blocks for modular and pre-assembled connector systems

Pre-assembled units are:

- Easy to test before assembly
- Terminal blocks available in two widths:  
3.5 mm, for conductors up to 1.5 mm<sup>2</sup> (AWG 16)  
5.2 mm, for conductors up to 4 mm<sup>2</sup> (AWG 12)
- Protection against accidental contact in unmated condition
- Coding provides protection against mismatching
- Allow quick replacement of function assemblies, if necessary
- Clearly marked for fast and reliable connections

Same profile makes X-COM<sup>®</sup> S and TOPJOB<sup>®</sup> S compatible for:

- Commoning
- Marking

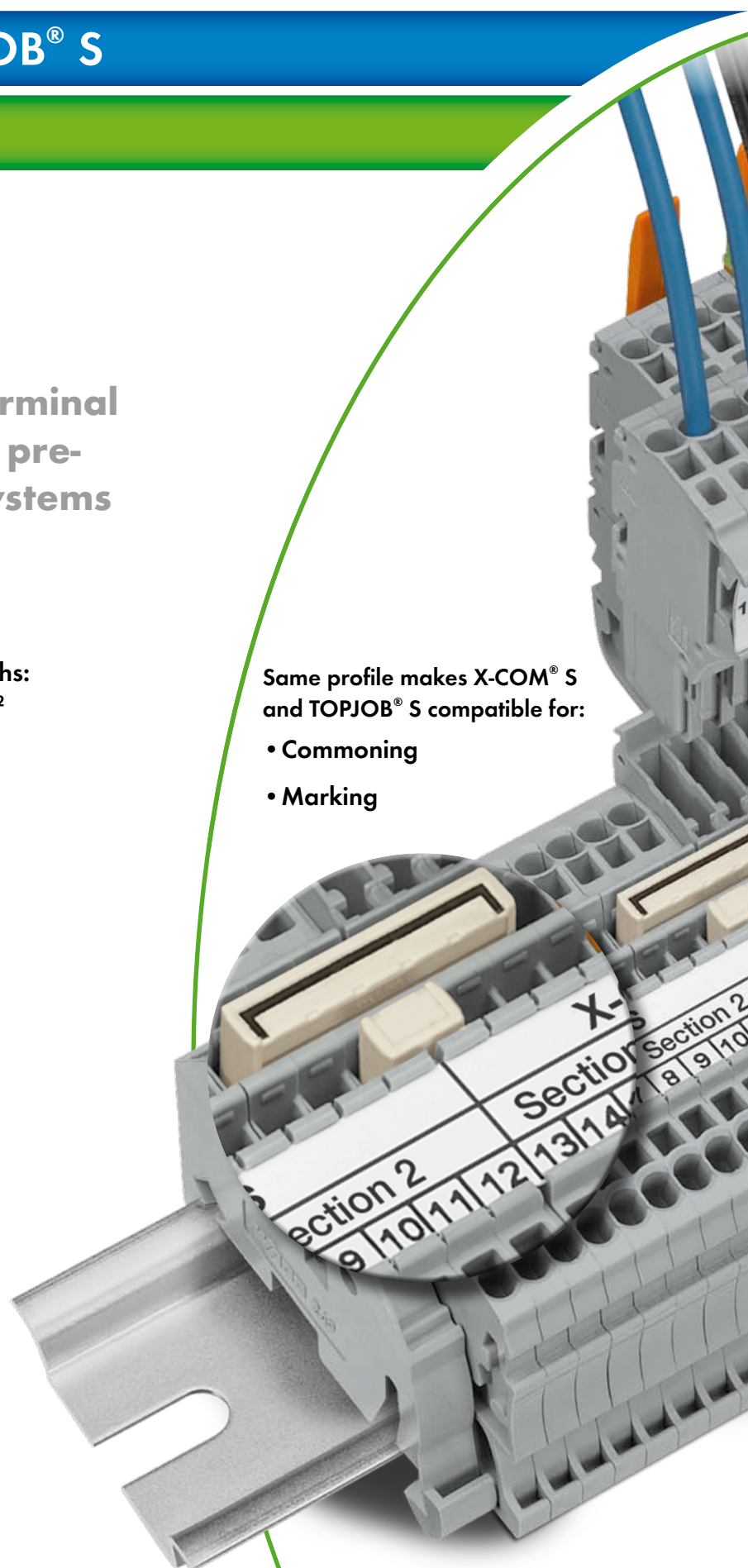

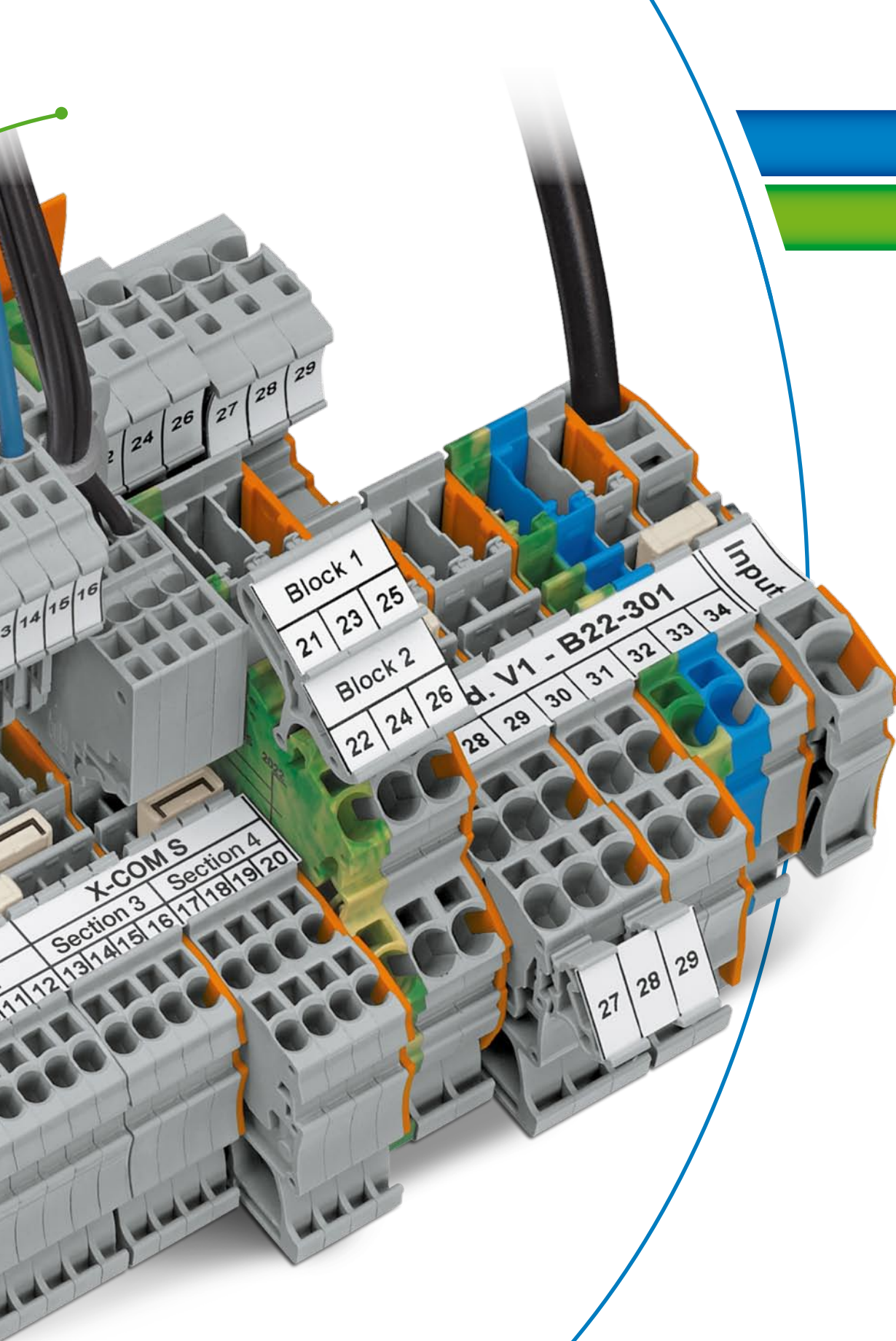

- Coding provides additional safety
- Cost-effective, pre-assembled and tested units
- Protected against accidental contact on both sides

# TOPJOB® S is Pluggable: with X-COM® S and X-COM® S MINI Rail-Mounted Terminal Blocks

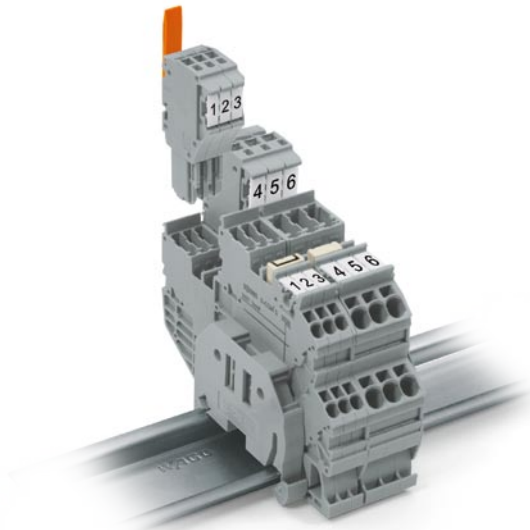

Save twice as much space with:

- X-COM® S MINI Terminal Blocks (3.5 mm wide) and
- Double-Deck Terminal Blocks

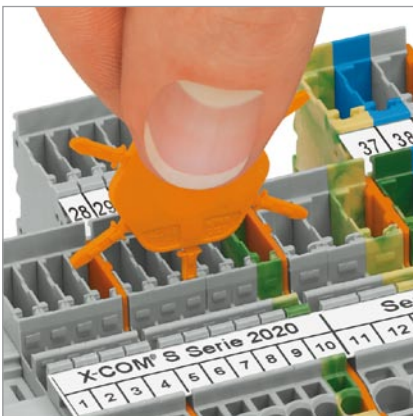

Easy coding:  
Insert coding pin into the corresponding slot and twist it off.

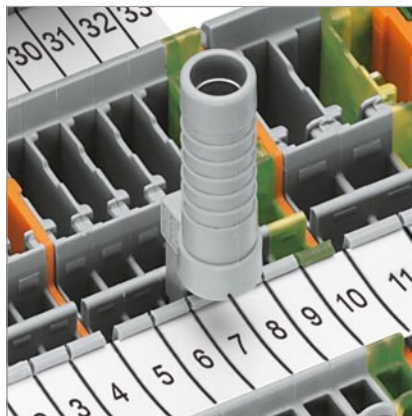

Test plug adapter for 4 mm test plugs - also suitable for X-COM® S MINI terminal blocks.

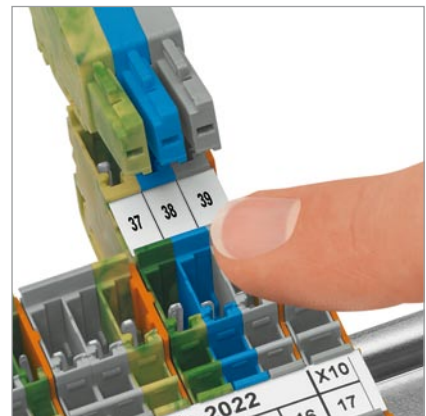

Carrier terminal blocks and female plugs are protected against accidental contact.

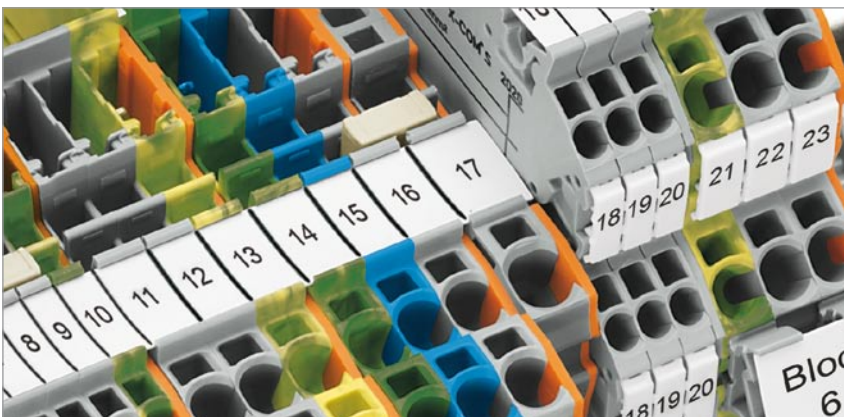

TOPJOB® S jumpers common X-COM® S terminal blocks.  
An end plate provides connection to TOPJOB® S terminal blocks.



Snap-on type adapter is an additional marking option.

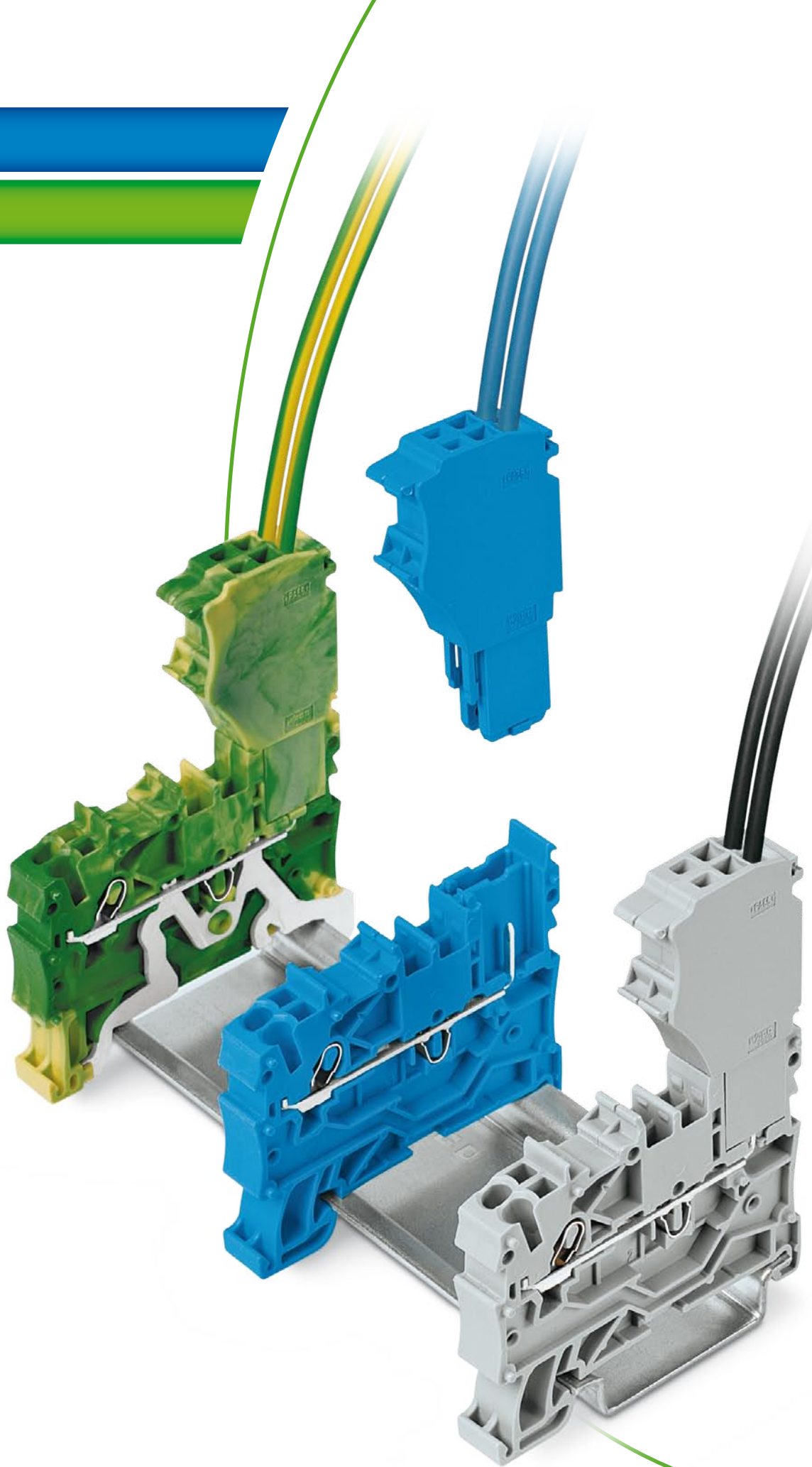

Comprehensive Range of Fu

For Specialty Applications

## Disconnect Terminal Blocks

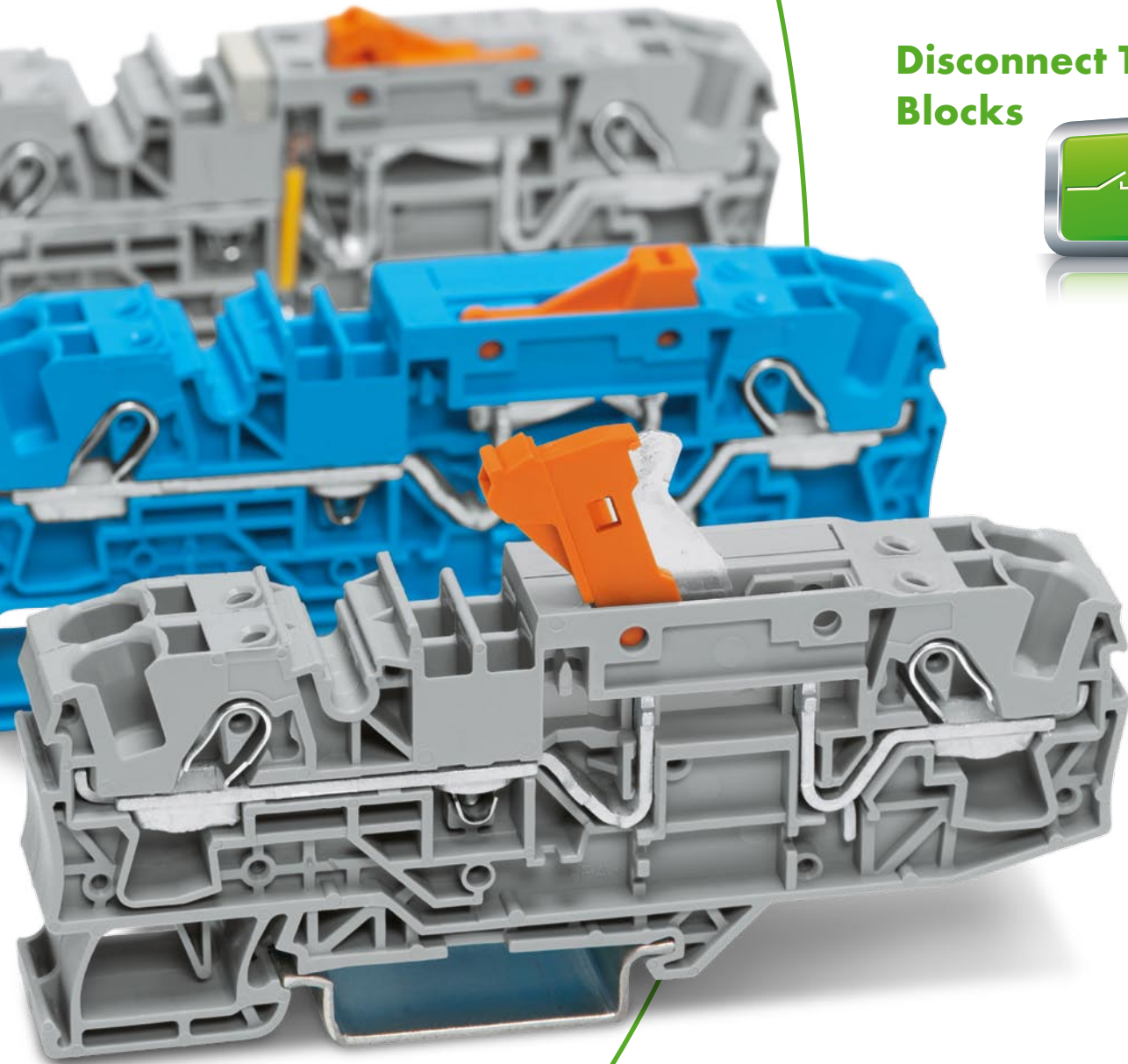

- Easy self-assembly of component plugs
- Wide variety of function terminal blocks
- Disconnect terminal block up to 1,000 V (e.g., photovoltaic applications)



## Component Plugs for Self-Assembly

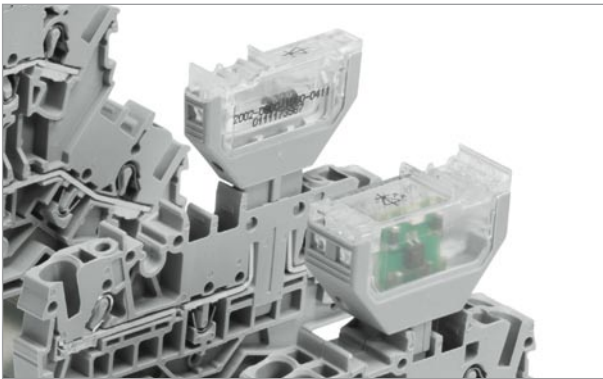

## Fuse Terminal Blocks

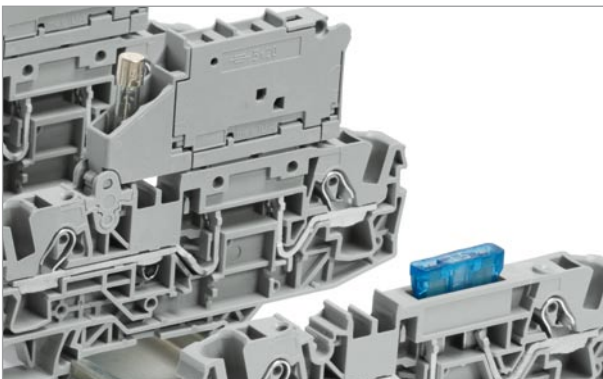

## LED and Diode Terminal Blocks



# Benefits at a Glance

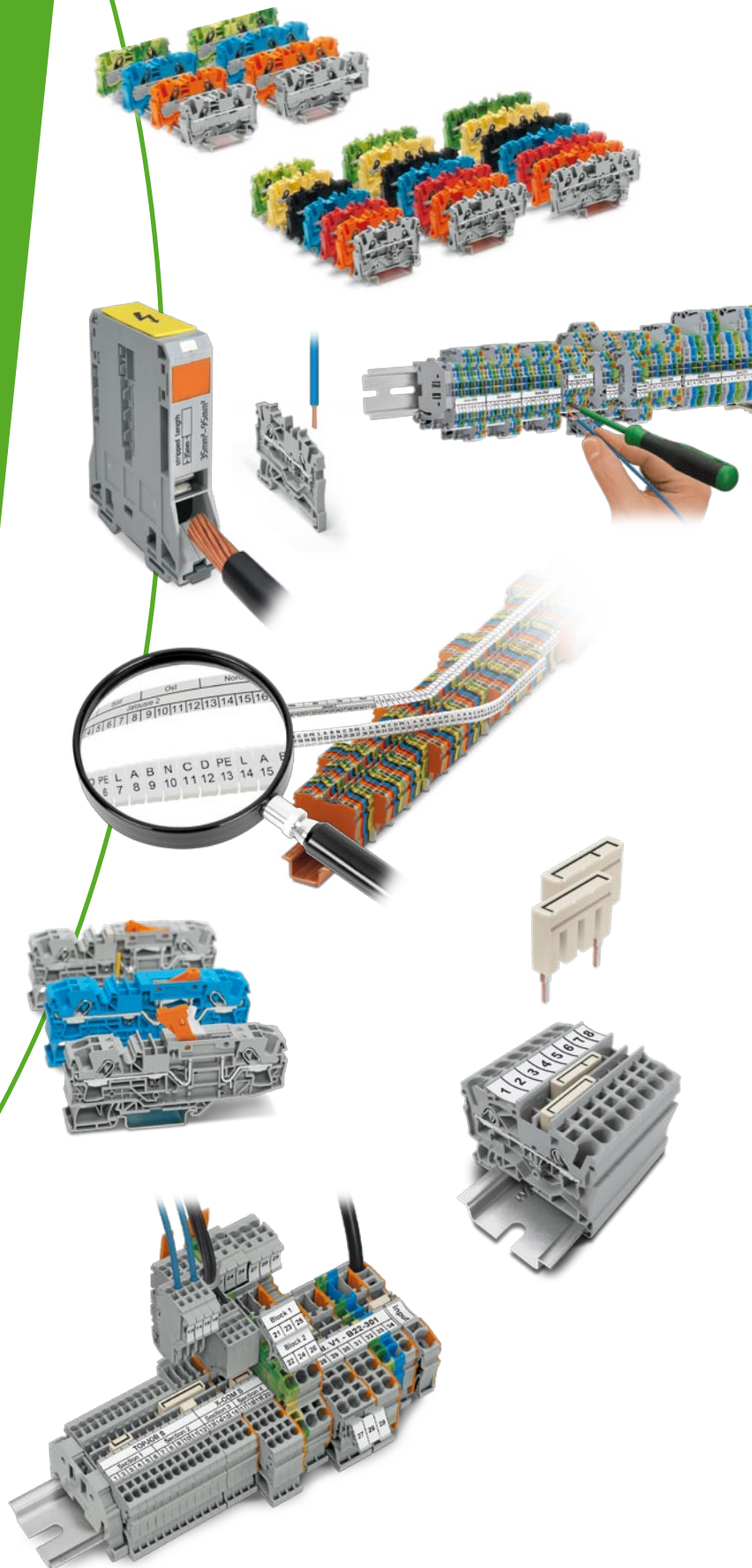

## The Industry's Largest Portfolio for Industrial, Building and Transportation Applications

- Industry's widest range of conductor sizes: 0.14–95 mm<sup>2</sup> (AWG 4/0–24)
- Comprehensive range of through and function terminal blocks
- Connect all conductor types

## TOPJOB® S – Vibration-Proof, Fast, Maintenance-Free WAGO – The Spring Pressure Connection Technology

- CAGE CLAMP® S for all conductor types
- Simple, push-in termination of solid and ferruled conductors
- The operating tool is captivated, holding the clamping unit open, while the conductor is inserted.

## The Smallest, the Biggest and Always the Right Terminal Blocks

- Industry's widest range of spring-clamp terminal blocks
- For conductor sizes 0.14–95 mm<sup>2</sup> (AWG 4/0–24)
- Full 2.5 mm<sup>2</sup> (AWG 14) conductor termination in just 4.2 mm terminal block width

## Typically WAGO – The Fastest and Most Efficient Marking System

- Continuous marker strip fits across terminal blocks of different sizes
- Significant time savings and easier identification via multi-line marking
- Reduces marking costs

## TOPJOB® S Jumper System Ready to Solve Any Commoning Tasks

- Comprehensive jumper system for virtually any application
- Custom jumpers can be created
- Simple, easy-to-use design

## X-COM® S and TOPJOB® S Create Synergies

- Coding provides additional safety
- Cost-effective, pre-assembled and tested units
- Protected against accidental contact on both sides

## Comprehensive Range of Function Terminal Blocks – For Specialty Applications

- Easy self-assembly of component plugs
- Wide variety of function terminal blocks
- Disconnect terminal block up to 1,000 V (e.g., photovoltaic applications)

**For more information on  
WAGO products, please visit  
[www.wago.com](http://www.wago.com).**

WAGO Kontakttechnik GmbH & Co. KG  
Postfach 2880 · 32385 Minden  
Hansastraße 27 · 32423 Minden  
Phone:  
Headquarters +49 (0)571 887 - 0  
Sales +49 (0)571 887 - 222  
Order Service +49 (0)571 887 - 333  
Technical Support +49 (0)571 887 - 77828  
Fax: +49 (0)571 887 - 169  
E-mail: [info@wago.com](mailto:info@wago.com)  
Online: [www.wago.com](http://www.wago.com)

