

POWER RELAY

1 POLE - 17A Tab Terminal

FTR-K1T Series

■ FEATURES

- SPST 17A
 - Low profile (height: 15.7mm)
 - HIGH INSULATION
 - Insulation distance (between coil and contacts): 10mm min.
 - Dielectric strength: 5KV
 - Surge strength: 10KV
 - UL F class wire insulation
 - Low coil power (400mW)
 - Cadmium free contacts
 - SAFETY STANDARDS
 - UL, CSA, VDE, SEMKO approved
 - UL, CSA TV-5 rating approved (1 form A type)
 - Flux proof, RTII
 - RoHS compliant
- Please see page 6 for more information

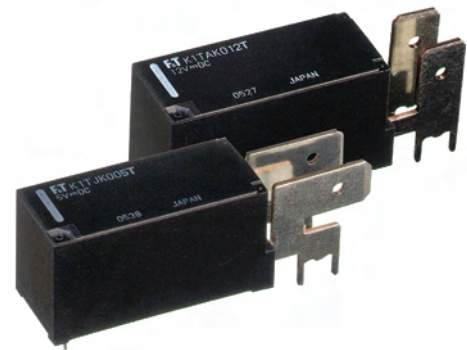

■ PARTNUMBER INFORMATION

[Example] FTR-K1T A K 012 T - BG
 (a) (b) (c) (d) (e) (f)

(a)	Relay type	FTR-K1T: FTR-K1T Series
(b)	Contact configuration	A : Vertical J : Horizontal
(c)	Coil type	K : Standard type (400mW) / Flux proof
(d)	Coil rated voltage	012 : 5...110VDC Coil rating table at page 3
(e)	Contact material	T : AgSnO ₂
(f)	Special type	Nil : Standard type (without gold plate) BG : Gold plate 3μm

Actual marking does not carry the type name : "FTR"

E.g.: Ordering code: FTR-K1TAK005T

Actual marking: K1TAK012T

FTR-K1T SERIES

■ SPECIFICATION

Item	FTR-K1T (A, J) K () T		
Contact Data	Configuration	1 form A	
	Construction	Single	
	Material	AgSnO ₂	
	Resistance (initial)	Max. 100mOhm at 1A, 6VDC	
	Contact rating (resistive)	17A, 250VAC	
	Max. carrying current * ¹	20A	
	Max. inrush current	78A, 120VAC (lamp load)	
	Max. switching voltage	440VAC	
	Max. switching power	4,250VA	
	Min. switching load * ²	100mA, 5VDC	
Life	Mechanical	Min. 20 x 10 ⁶ operations	
	Electrical	AC contact rating Min. 100 x 10 ³ operations	
Coil Data	Rated power (20 °C)	400mW (430mW at 48V coil)	
	Operate power (20 °C)	200mW (210mW at 48V coil)	
	Operating temperature range	-40 °C to +105 °C (no frost)	
Timing Data	Operate (at nominal voltage)	Max. 15ms (without bounce, no diode)	
	Release (at nominal voltage)	Max. 5ms (without bounce, no diode)	
Insulation	Resistance (initial)	Min. 1,000MOhm at 500VDC	
	Dielectric strength	Open contacts	1,000VAC (50/60Hz) 1min
		Contacts to coil	5,000VAC (50/60Hz) 1min
	Surge strength	Coil to contacts	10,000V / 1.2 x 50µs standard wave
	Clearance		10mm
	Creepage		10mm
	EN61810-1, VDE0435	Voltage	250V
		Pollution degree	3
		Material group	III a
	Category	C / 250V (Reference voltage) (VDE0110b)	
Other	Vibration resistance	Misoperation≥1us	10 to 55Hz double amplitude 0.7mm
		Endurance	10 to 55Hz double amplitude 1.5mm
	Shock	Misoperation≥1us	100m/s ² (11 ± 1ms)
		Endurance	1,000m/s ² (6 ± 1ms)
	Weight		Approximately 13g
	Sealing		Flux proof, RTII

* 1: Need to consider the heat from PCB when max. current is more than 10A.

* 2: Minimum switching loads mentioned above are reference values. Please perform the confirmation test with actual load before production since reference values may vary according to switching frequencies, environmental conditions

FTR-K1T SERIES

■ COIL RATING

Coil Code	Rated Coil Voltage (VDC)	Coil Resistance +/- 10% (Ohm)	Must Operate Voltage (VDC) *	Must Release-Voltage (VDC) *	Max. Coil Voltage (VDC)	Rated Power (mW)
005	5	62	3.5	0.5	12.2	400
006	6	90	4.2	0.6	14.7	
009	9	202	6.3	0.9	22	
012	12	360	8.4	1.2	29.4	
018	18	810	12.6	1.8	44.1	
022	22	1,210	15.4	2.2	53.9	
024	24	1,440	16.8	2.4	58.8	
028	28	1,960	19.6	2.8	68.6	
048	48	5,360	33.6	4.8	117.6	430
060	60	8,570	42.0	6.0	147.0	420
110	110	28,800	77.0	11.0	269.5	

Note: All values in the table are valid for 20°C and zero contact current.

* Specified operate values are valid for pulse wave voltage.

■ SAFETY STANDARDS

Type	Compliance	Contact rating
		FTR-K1T (A, J) K () T
UL	UL 508	Flammability: UL 94-V0 (plastics)
	E63614	17A, 277VAC (resistive) 1 HP, 277VAC
CSA	C22.2 No. 14	1/2 HP, 125VAC TV-5, 120VAC Pilot duty: A300
	LR 40304	
VDE	0435, 0631, 0700, 0860, 40013848	17A, 250VAC (cosφ=1), 105°C 3.5A, 250VAC (cosφ=0.4), 105°C 12A, 250VAC (cosφ=1), 125°C 5A/80A 250VAC
SEMKO	EN 61058-1:1992 and A1 EN 61095:1993 and A1+A11	250VAC, 17 (3)A 40T105 5A/80A 250VAC 40T85

Complies with NEMKO, DEMKO, FIMKO

FTR-K1T SERIES

CHARACTERISTIC DATA

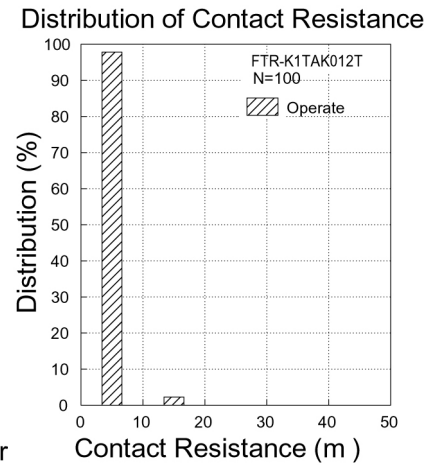
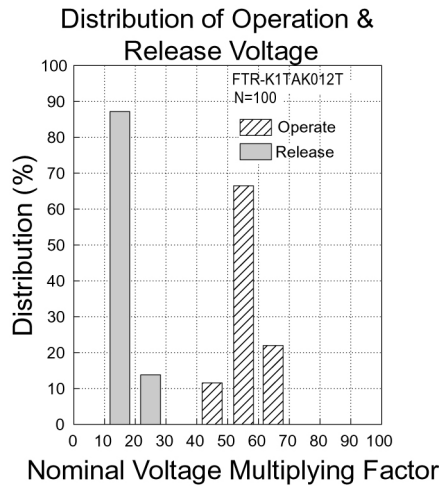
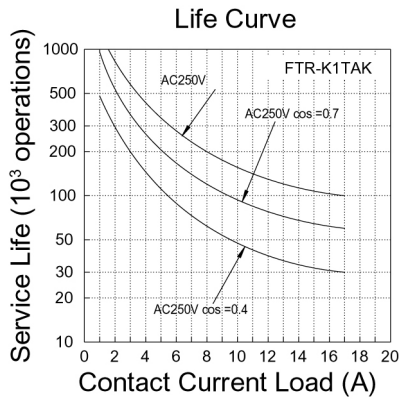
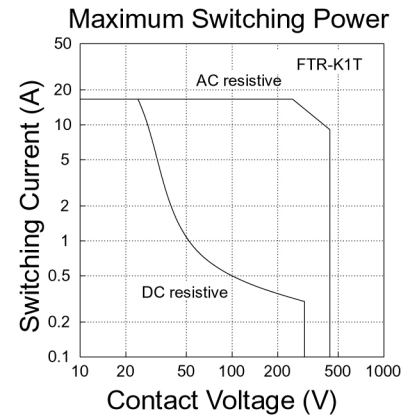
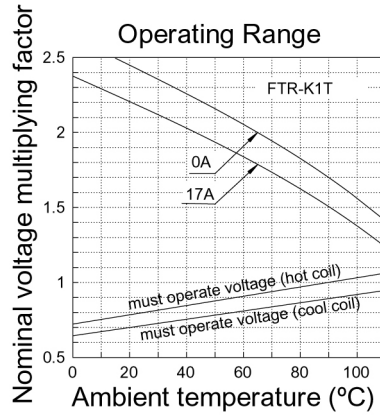
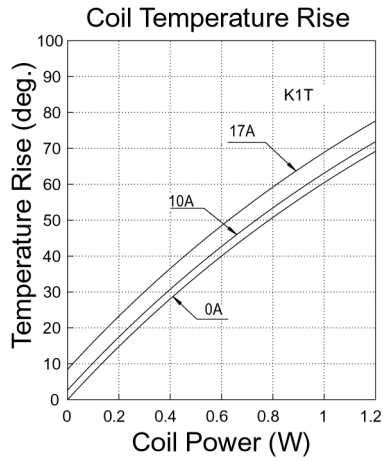

FTR-K1T SERIES

■ DIMENSIONS

- Dimensions

FTR-K1TAK

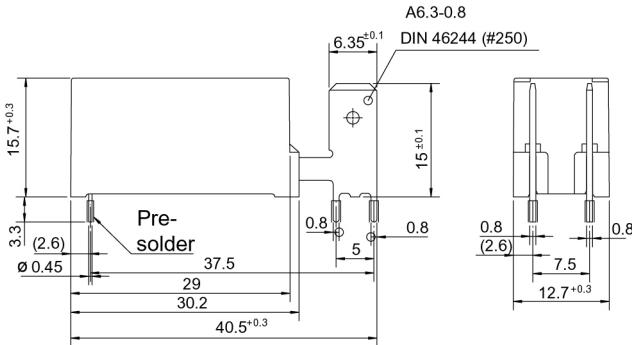

- Schematics (BOTTOM VIEW)

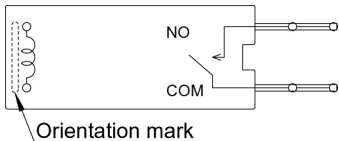

- PC board mounting hole layout (BOTTOM VIEW)

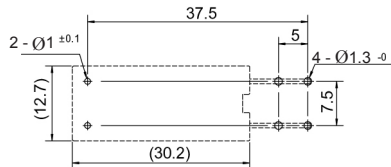

- Dimensions

FTR-KTJK

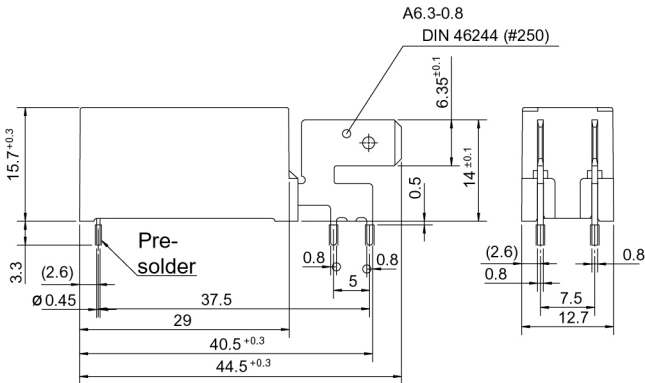

- Schematics (BOTTOM VIEW)

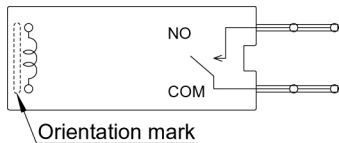

- PC board mounting hole layout (BOTTOM VIEW)

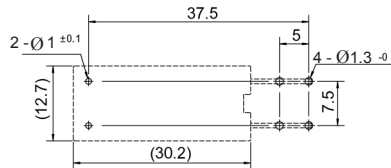

Unit: mm

RoHS Compliance and Lead Free Information

1. General Information

- All signal and power relays produced by Fujitsu Components are compliant with RoHS directive 2002/95EC including amendments.
- Cadmium as used in electrical contacts is exempted from the RoHS directives on October 21st, 2005. (Amendment to Directive 2002/95/EC)
- All of our signal and power relays are lead-free. Please refer to Lead-Free Status Info for older date codes at: <http://www.fujitsu.com/us/downloads/MICRO/fcai/relays/lead-free-letter.pdf>
- Lead free solder plating on relay terminals is Sn-3.0Ag-0.5Cu, unless otherwise specified. This material has been verified to be compatible with PbSn assembly process.

2. Recommended Lead Free Solder Profile

- Recommended solder Sn-3.0Ag-0.5Cu.

Flow Solder condition:

Pre-heating: maximum 120°C
Soldering: dip within 5 sec. at
260°C solder bath

Solder by Soldering Iron:

Soldering Iron
Temperature: maximum 360°C
Duration: maximum 3 sec.

We highly recommend that you confirm your actual solder conditions

3. Moisture Sensitivity

- Moisture Sensitivity Level standard is not applicable to electromechanical relays, unless otherwise indicated.

4. Tin Whiskers

- Dipped SnAgCu solder is known as presenting a low risk to tin whisker development. No considerable length whisker was found by our in house test.

FTR-K1T SERIES

Fujitsu Components International Headquarter Offices

Japan

Fujitsu Component Limited
Gotanda-Chuo Building
3-5, Higashigotanda 2-chome, Shinagawa-ku
Tokyo 141, Japan
Tel: (81-3) 5449-7010
Fax: (81-3) 5449-2626
Email: promothq@ft.ed.fujitsu.com
Web: www.fcl.fujitsu.com

North and South America

Fujitsu Components America, Inc.
250 E. Caribbean Drive
Sunnyvale, CA 94089 U.S.A.
Tel: (1-408) 745-4900
Fax: (1-408) 745-4970
Email: components@us.fujitsu.com
Web: <http://us.fujitsu.com/components>

Europe

Fujitsu Components Europe B.V.
Diamantlaan 25
2132 WV Hoofddorp
Netherlands
Tel: (31-23) 5560910
Fax: (31-23) 5560950
Email: info@fceu.fujitsu.com
Web: emea.fujitsu.com/components/

Asia Pacific

Fujitsu Components Asia Ltd.
102E Pasir Panjang Road
#01-01 Citilink Warehouse Complex
Singapore 118529
Tel: (65) 6375-8560
Fax: (65) 6273-3021
Email: fcal@fcal.fujitsu.com
Web: <http://www.fujitsu.com/sg/services/micro/components/>

©2010 Fujitsu Components Europe B.V. All rights reserved. All trademarks or registered trademarks are the property of their respective owners.

The contents, data and information in this datasheet are provided by Fujitsu Component Ltd. as a service only to its user and only for general information purposes.

The use of the contents, data and information provided in this datasheet is at the users' own risk.

Fujitsu has assembled this datasheet with care and will endeavor to keep the contents, data and information correct, accurate, comprehensive, complete and up to date.

Fujitsu Components Europe B.V. and affiliated companies do however not accept any responsibility or liability on their behalf, nor on behalf of its employees, for any loss or damage, direct, indirect or consequential, with respect to this datasheet, its contents, data, and information and related graphics and the correctness, reliability, accuracy, comprehensiveness, usefulness, availability and completeness thereof.

Nor do Fujitsu Components Europe B.V. and affiliated companies accept on their behalf, nor on behalf of its employees, any responsibility or liability for any representation or warrant of any kind, express or implied, including warranties of any kind for merchantability or fitness for particular use, with respect to these datasheets, its contents, data, information and related graphics and the correctness, reliability, accuracy, comprehensiveness, usefulness, availability and completeness thereof. Rev. August 12, 2010