

DATA SHEET

SURFACE-MOUNT CERAMIC MULTILAYER CAPACITORS

General purpose & High capacitance

Class 2, X5R

6.3 V TO 50 V

10 nF to 100 μ F

RoHS compliant



SCOPE

This specification describes X5R series chip capacitors with lead-free terminations.

APPLICATIONS

- PCs, Hard disk, Game PCs
- Power supplies
- DVDs, Camcorders
- Mobile phones
- Data processing

FEATURES

- Supplied in tape on reel
- Nickel-barrier end termination
- RoHS compliant
- Halogen Free compliant

ORDERING INFORMATION - GLOBAL PART NUMBER, PHYCOMP

CTC & I2NC

All part numbers are identified by the series, size, tolerance, TC material, packing style, voltage, process code, termination and capacitance value.

YAGEO BRAND ordering code

GLOBAL PART NUMBER (PREFERRED)

CC xxxx x x **X5R** x **BB** xxx
 (1) (2) (3) (4) (5)

(1) SIZE – INCH BASED (METRIC)

- 0201 (0603)
- 0402 (1005)
- 0603 (1608)
- 0805 (2012)
- 1206 (3216)
- 1210 (3225)
- 1812 (4532)

(2) TOLERANCE

- K = ±10%
- M = ±20%

(3) PACKING STYLE

- R = Paper taping reel; Reel 7 inch
- K = Blister taping reel; Reel 7 inch
- P = Paper taping reel; Reel 13 inch
- F = Blister taping reel; Reel 13 inch
- C = Bulk case

(4) RATED VOLTAGE

- 4 = 4 V
- 5 = 6.3 V
- 6 = 10 V
- 7 = 16 V
- 8 = 25 V
- 9 = 50 V

(5) CAPACITANCE VALUE

2 significant digits+number of zeros
 The 3rd digit signifies the multiplying factor, and letter R is decimal point
 Example: 103 = 10 × 10³ = 10,000 pF = 10 nF

PHYCOMP BRAND ordering codes

GLOBAL PART NUMBER (preferred), PHYCOMP CTC (for North America) and I2NC (traditional) codes are acceptable to order Phycomp brand products.

GLOBAL PART NUMBER (PREFERRED)

For detailed information of GLOBAL PART NUMBER and ordering example, please refer to page 2.

I2NC CODE

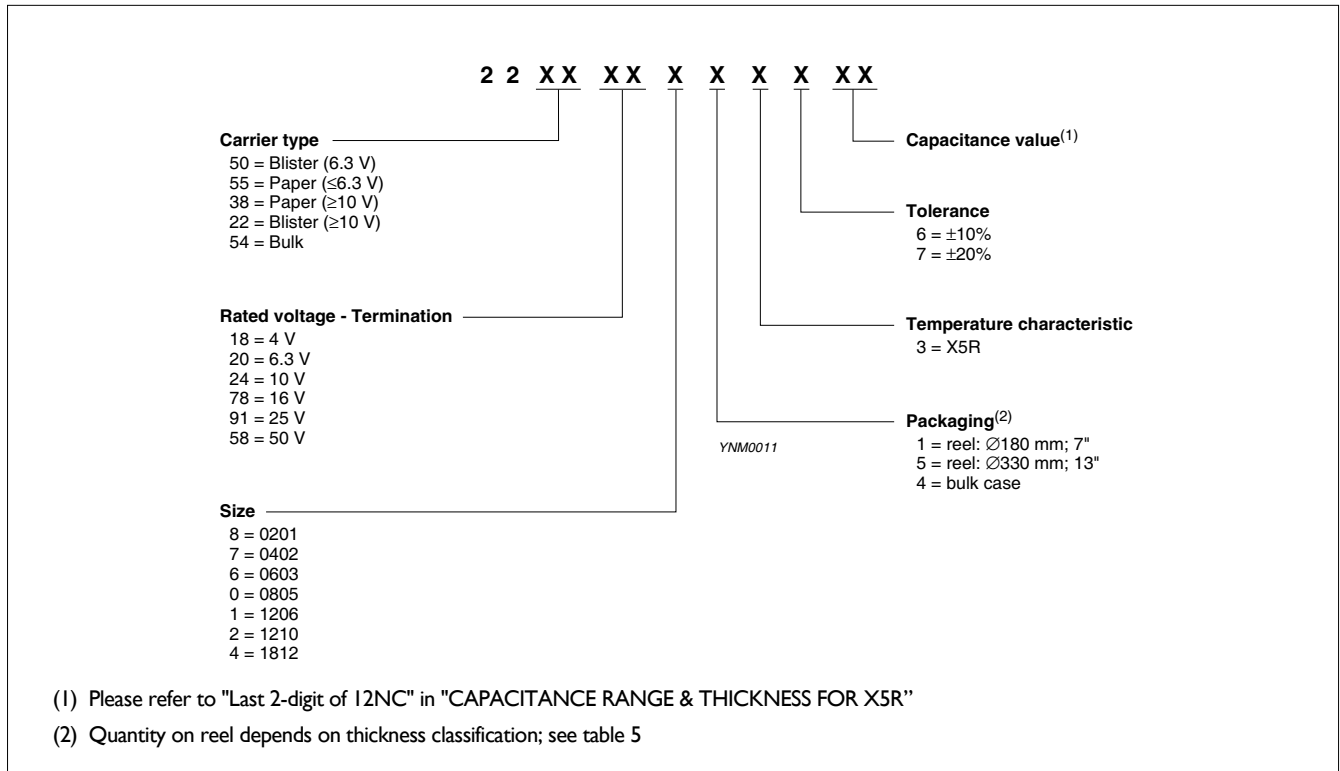

PHYCOMP CTC CODE (FOR NORTH AMERICA)

Example: 06032B225M5B20D

0603	2B	225	M	5	B	2	0	D
Size code	Temp. Char.	Capacitance in pF	Tolerance	Voltage	Termination	Packing	Marking	Range identifier
0201	2B = X5R	101 = 100 pF; the third digit signifies the multiplying factor:	K = $\pm 10\%$	4 = 4 V	B = NiSn	2 = 180 mm 7" paper	0 = no marking	D = Class 2 MLCC
0402			M = $\pm 20\%$	5 = 6.3 V		3 = 330 mm 13" paper		
0603				6 = 10 V		B = 180 mm 7" blister		
0805		0 = $\times 1$		7 = 16 V		F = 330 mm 13" blister		
1206		1 = $\times 10$		8 = 25 V		P = Bulk case		
1210		2 = $\times 100$		9 = 50 V				
1812		3 = $\times 1,000$						
		4 = $\times 10,000$						
		5 = $\times 100,000$						
		6 = $\times 1,000,000$						
		7 = $\times 10,000,000$						

CONSTRUCTION

The capacitor consists of a rectangular block of ceramic dielectric in which a number of interleaved metal electrodes are contained. This structure gives rise to a high capacitance per unit volume.

The inner electrodes are connected to the two end terminations and finally covered with a layer of plated tin (NiSn). The terminations are lead-free. A cross section of the structure is shown in Fig.1.

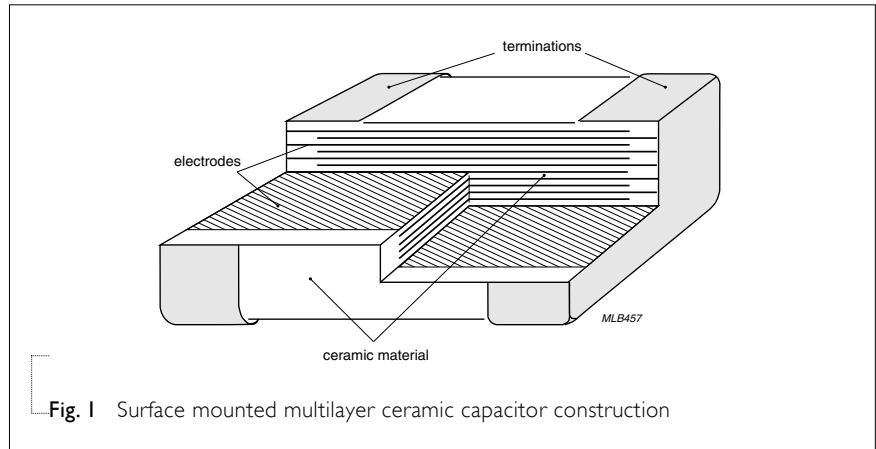

Fig. 1 Surface mounted multilayer ceramic capacitor construction

DIMENSION

Table I For outlines see fig. 2

TYPE	L ₁ (mm)	W (mm)	T (MM)	L ₂ / L ₃ (mm)		L ₄ (mm)
				min.	max.	min.
0201	0.6 ±0.03	0.3 ±0.03	Refer to table 2 to 4	0.10	0.20	0.20
0402	1.0 ±0.05	0.5 ±0.05		0.20	0.30	0.40
0603	1.6 ±0.10	0.8 ±0.10		0.20	0.60	0.40
0805	2.0 ±0.10 ⁽¹⁾	1.25 ±0.10 ⁽¹⁾		0.25	0.75	0.55
	2.0 ±0.20 ⁽²⁾	1.25 ±0.20 ⁽²⁾				
1206	3.2 ±0.15 ⁽¹⁾	1.6 ±0.15 ⁽¹⁾		0.25	0.75	1.40
	3.2 ±0.20 ⁽²⁾	1.6 ±0.20 ⁽²⁾				
	3.2 ±0.20 ⁽¹⁾	2.5 ±0.20 ⁽¹⁾				
1210	3.2 ±0.30 ⁽²⁾	2.5 ±0.30 ⁽²⁾		0.25	0.75	1.40
	3.2 ±0.40 ⁽³⁾	2.5 ±0.30 ⁽³⁾				
1812	4.5 ±0.20 ⁽¹⁾	3.2 ±0.20	0.25	0.75	2.20	
	4.5 ±0.40 ⁽²⁾					

NOTE

1. Dimension for size 0805 to 1812, C < 1 μF
2. Dimension for size 0805 to 1812, C ≥ 1 μF
3. Dimension for size 1210, C = 100 μF

OUTLINES

For dimension see Table I

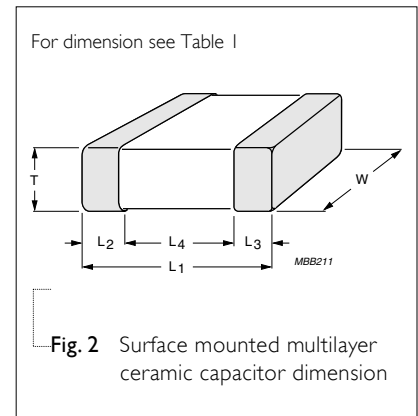

Fig. 2 Surface mounted multilayer ceramic capacitor dimension

CAPACITANCE RANGE & THICKNESS FOR X5R

Table 2 Sizes from 0201 to 0402

CAP.	Last 2-digit of	0201			0402			
		12NC	6.3 V	10 V	16 V	6.3 V	10 V	16 V
10 nF	36	0.3±0.03	0.3±0.03	0.3±0.03	0.5±0.05	0.5±0.05	0.5±0.05	0.5±0.05
15 nF	38							
22 nF	41							
33 nF	43							
47 nF	45							
68 nF	47							
100 nF	49		0.3±0.03					
150 nF	52							
220 nF	54							
330 nF	56							
470 nF	58							
680 nF	61							
1.0 μF	63							
2.2 μF	67							
4.7 μF	72							
10 μF	76							
22 μF	81							
47 μF	85							
100 μF	89							

NOTE

1. Values in shaded cells indicate thickness class in mm
2. Capacitance value of non E-6 series is on request

CAPACITANCE RANGE & THICKNESS FOR X5R

Table 3 Sizes from 0603 to 0805

CAP.	Last 2-digit of	0603				0805			
		12NC	6.3 V	10 V	16 V	25 V	6.3 V	10 V	16 V
10 nF	36								
15 nF	38								
22 nF	41								
33 nF	43								
47 nF	45								
68 nF	47								
100 nF	49								
150 nF	52								
220 nF	54								
330 nF	56								
470 nF	58				0.8±0.1				
680 nF	61	0.8±0.1	0.8±0.1	0.8±0.1				0.85±0.1 1.25±0.2	1.25±0.2
1.0 µF	63					0.85±0.1 1.25±0.2	0.85±0.1 1.25±0.2		
2.2 µF	67							0.85±0.1 1.25±0.2	
4.7 µF	72							1.25±0.2	1.25±0.2
10 µF	76	0.8±0.15							
22 µF	81					1.25±0.2			
47 µF	85								
100 µF	89								

NOTE

1. Values in shaded cells indicate thickness class in mm
2. Capacitance value of non E-6 series is on request

CAPACITANCE RANGE & THICKNESS FOR X5R

Table 4 Sizes from 1206 to 1812

CAP.	Last 2-digit of	1206				1210				1812
		12NC	6.3 V	10 V	16 V	25 V	6.3 V	10 V	16 V	25 V
10 nF	36									
15 nF	38									
22 nF	41									
33 nF	43									
47 nF	45									
68 nF	47									
100 nF	49									
150 nF	52									
220 nF	54									
330 nF	56									
470 nF	58									
680 nF	61									
1.0 μF	63									
2.2 μF	67				1.15±0.1					
4.7 μF	72	1.15±0.1	1.15±0.1	1.15±0.1						
10 μF	76		1.6±0.2	1.6±0.2	1.6±0.2			1.9±0.2	1.9±0.2	
22 μF	81	1.6±0.2				2.0±0.2 (3) 2.5±0.2	2.0±0.2 (3) 2.5±0.2	2.5±0.2		
47 μF	85									2.5±0.2
100 μF	89					2.5±0.2				3.2±0.3

NOTE

1. Values in shaded cells indicate thickness class in mm
2. Capacitance value of non E-6 series is on request
3. For special ordering code, please contact local sales force before order

THICKNESS CLASSES AND PACKING QUANTITY

Table 5

SIZE CODE	THICKNESS CLASSIFICATION	TAPE WIDTH QUANTITY PER REEL	Ø180 MM / 7 INCH		Ø330 MM / 13 INCH		QUANTITY PER BULK CASE
			Paper	Blister	Paper	Blister	
0201	0.3 ±0.03 mm	8 mm	15,000	---	50,000	---	---
0402	0.5 ±0.05 mm	8 mm	10,000	---	50,000	---	50,000
0603	0.8 ±0.1 mm	8 mm	4,000	---	15,000	---	15,000
0805	0.6 ±0.1 mm	8 mm	4,000	---	20,000	---	10,000
	0.85 ±0.1 mm	8 mm	4,000	---	15,000	---	8,000
	1.25 ±0.2 mm	8 mm	---	3,000	---	10,000	5,000
1206	0.6 ±0.1 mm	8 mm	4,000	---	20,000	---	---
	0.85 ±0.1 mm	8 mm	4,000	---	15,000	---	---
	1.00 / 1.15 ±0.1 mm	8 mm	---	3,000	---	10,000	---
	1.25 ±0.2 mm	8 mm	---	3,000	---	10,000	---
	1.6 ±0.15 mm	8 mm	---	2,500	---	10,000	---
1210	1.6 ±0.2 mm	8 mm	---	2,000	---	10,000	---
	0.6 / 0.7 ±0.1 mm	8 mm	---	4,000	---	15,000	---
	0.85 ±0.1 mm	8 mm	---	4,000	---	10,000	---
	1.15 ±0.1 mm	8 mm	---	3,000	---	10,000	---
	1.15 ±0.15 mm	8 mm	---	3,000	---	10,000	---
	1.25 ±0.2 mm	8 mm	---	3,000	---	---	---
	1.5 ±0.1 mm	8 mm	---	2,000	---	---	---
	1.6 / 1.9 ±0.2 mm	8 mm	---	2,000	---	---	---
1808	2.0 ±0.2 mm	8 mm	---	2,000 1,000	---	---	---
	2.5 ±0.2 mm	8 mm	---	1,000 500	---	---	---
	1.15 ±0.15 mm	12 mm	---	3,000	---	---	---
	1.25 ±0.2 mm	12 mm	---	3,000	---	---	---
	1.35 ±0.15 mm	12 mm	---	2,000	---	---	---
	1.5 ±0.1 mm	12 mm	---	2,000	---	---	---
1812	1.6 ±0.2 mm	12 mm	---	2,000	---	---	---
	2.0 ±0.2 mm	12 mm	---	2,000	---	---	---
	0.6 / 0.85 ±0.1 mm	12 mm	---	2,000	---	---	---
	1.15 ±0.1 mm	12 mm	---	1,500	---	---	---
	1.15 ±0.15 mm	12 mm	---	1,500	---	---	---
	1.35 ±0.15 mm	12 mm	---	1,000	---	---	---
	1.5 ±0.1 mm	12 mm	---	1,000	---	---	---
	1.6 ±0.2 mm	12 mm	---	1,000	---	---	---
2.0 ±0.2 mm	12 mm	---	1,000	---	---	---	
	2.5 ±0.2 mm	12 mm	---	500	50,000	---	---

ELECTRICAL CHARACTERISTICS

X5R DIELECTRIC CAPACITORS; NISN TERMINATIONS

Unless otherwise stated all electrical values apply at an ambient temperature of 20±1 °C, an atmospheric pressure of 86 to 106 kPa, and a relative humidity of 63 to 67%.

Table 6

DESCRIPTION	VALUE
Capacitance range	10 nF to 100 µF
Capacitance tolerance	±10% and ±20%
Dissipation factor (D.F.)	
6.3 V	≤ 5%
Exception: 0402 ≥ 180 nF; 1210 ≥ 22 µF	≤ 7%
0201 ≥ 12 nF; 0402 ≥ 330 nF;	≤ 10%
0603 ≥ 2.2 µF; 0805 ≥ 1 µF;	
1206 ≥ 22 µF	
0805 ≥ 15 µF; 1210 ≥ 100 µF	≤ 15%
10 V	≤ 5%
Exception: 0402 ≥ 180 nF; 0805 ≥ 1 µF;	≤ 7%
1206 ≥ 6.8 µF	
0201 ≥ 100 nF; 0402 ≥ 330 nF;	≤ 10%
0603 ≥ 1 µF; 0805 ≥ 2.2 µF;	
1206 ≥ 10 µF	
16 V	≤ 5%
Exception: 0402 ≥ 180 nF; 0603 ≥ 680 nF;	≤ 7%
0805 ≥ 1 µF; 1206 ≥ 6.8 µF	
0402 ≥ 330 nF; 0603 ≥ 2.2 µF;	≤ 10%
0805 ≥ 10 µF; 1206 ≥ 10 µF;	
1210 ≥ 10 µF	
≥ 25 V	≤ 3.5%
Exception: 0402 ≥ 27 nF; 0603 ≥ 220 nF;	≤ 5%
0805 ≥ 2.2 µF; 1206 ≥ 4.7 µF;	
1210 ≥ 10 µF	
0402 ≥ 180 nF	≤ 7%
0805 ≥ 4.7 µF; 1206 ≥ 10 µF	≤ 10%
Insulation resistance after 1 minute at U _r (DC)	R _{ins} ≥ 10 GΩ or R _{ins} × C _r ≥ 500 seconds whichever is less
Maximum capacitance change as a function of temperature (temperature characteristic/coefficient):	±15%
Operating temperature range:	-55 °C to +85 °C

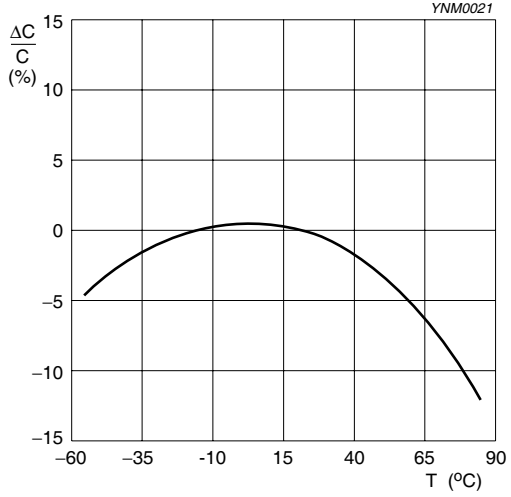

Fig. 3 Typical capacitance change as a function of temperature

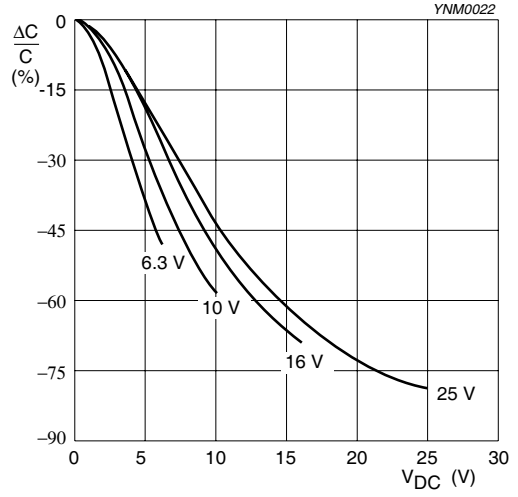

Fig. 4 Typical capacitance change with respect to the capacitance at 1 V as a function of DC voltage at 20 °C

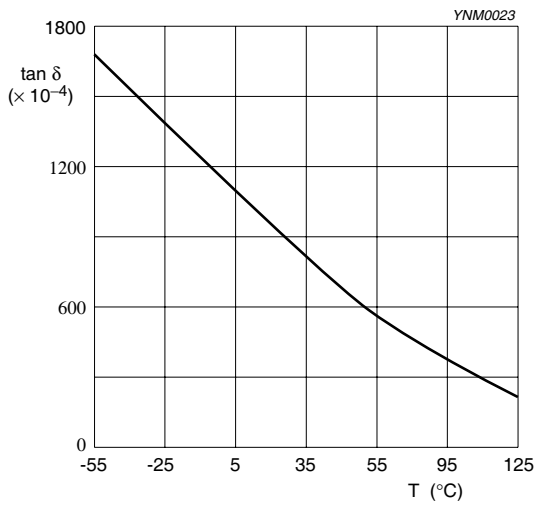

Fig. 5 Typical tan δ as a function of temperature

Size 0402 1 μ F / 10 V
Solid lines: Impedance / Dotted lines: ESR

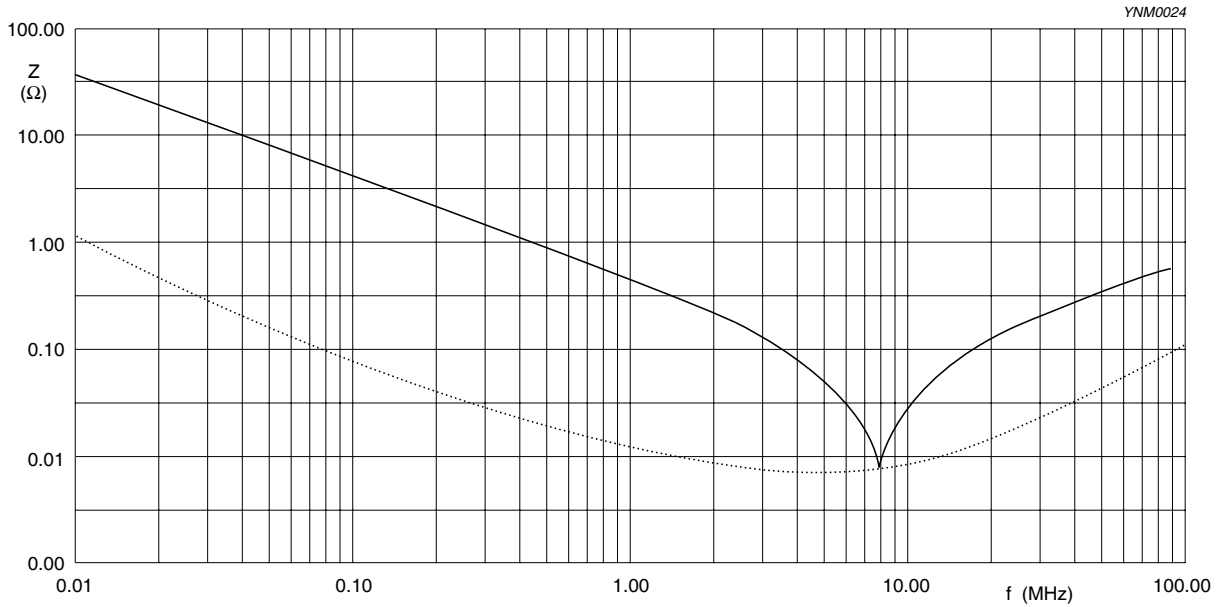

Fig. 6 Impedance ESR vs. frequency characteristics for multilayer chip capacitors

Size 0603 1 μ F / 10 V
Solid lines: Impedance / Dotted lines: ESR

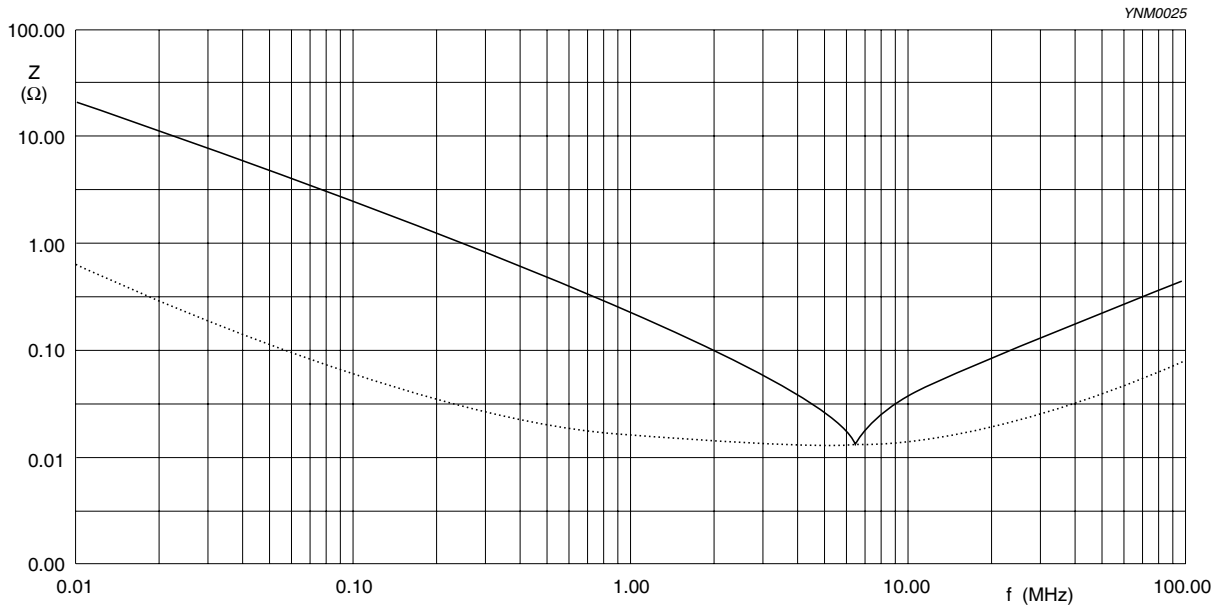

Fig. 7 Impedance ESR vs. frequency characteristics for multilayer chip capacitors

Size 0805 10 μ F / 6.3 V
Solid lines: Impedance / Dotted lines: ESR

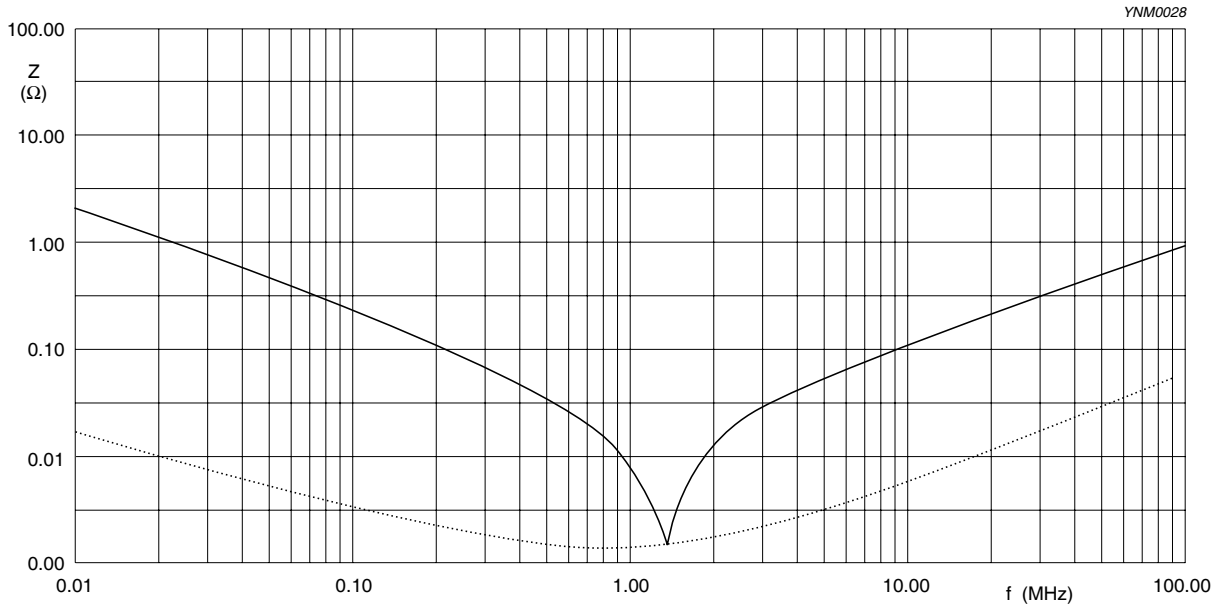

Fig. 8 Impedance ESR vs. frequency characteristics for multilayer chip capacitors

Size 1206 10 μ F / 16 V
Solid lines: Impedance / Dotted lines: ESR

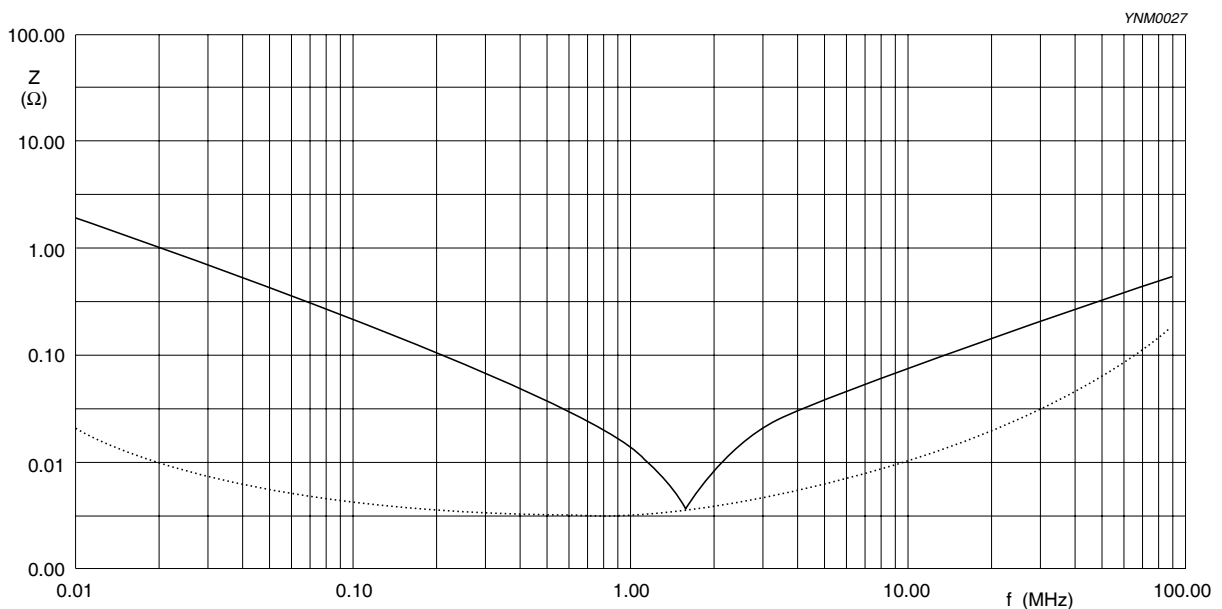

Fig. 9 Impedance ESR vs. frequency characteristics for multilayer chip capacitors

Size 1210 10 μ F / 25 V
Solid lines: Impedance / Dotted lines: ESR

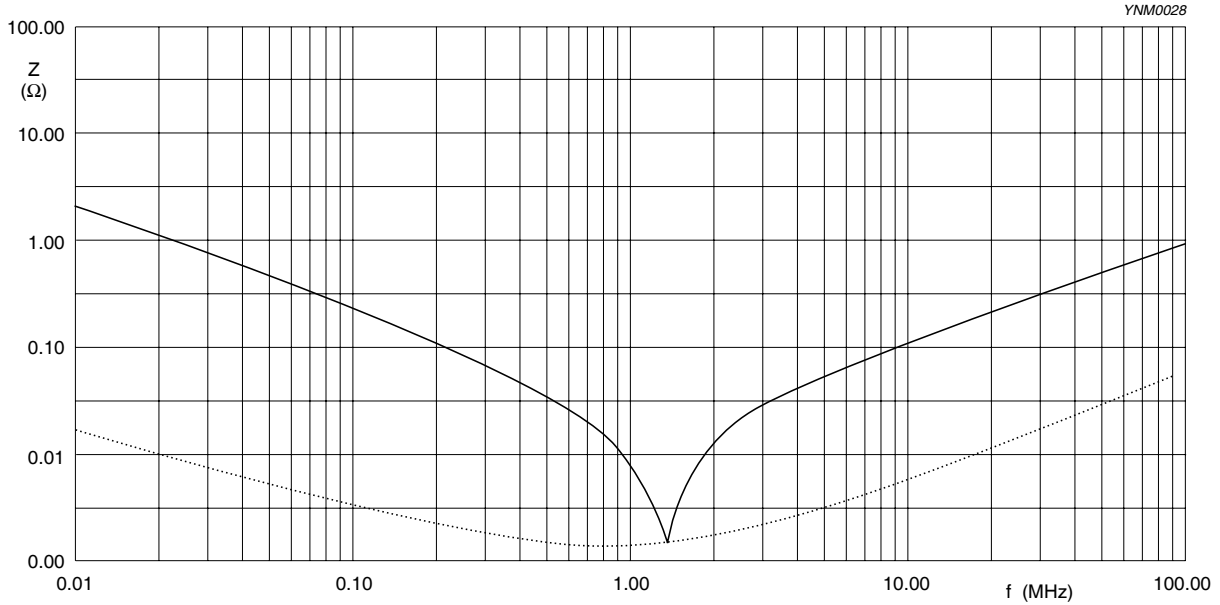

Fig. 10 Impedance ESR vs. frequency characteristics for multilayer chip capacitors

SOLDERING RECOMMENDATION

Table 7

SOLDERING METHOD	SIZE				
	0402	0603	0805	1206	\geq 1210
Reflow	\geq 0.1 μ F	\geq 1.0 μ F	\geq 2.2 μ F	\geq 4.7 μ F	Reflow only
Reflow/Wave	< 0.1 μ F	< 1.0 μ F	< 2.2 μ F	< 4.7 μ F	---

TESTS AND REQUIREMENTS
Table 8 Test procedures and requirements

TEST	TEST METHOD	PROCEDURE	REQUIREMENTS
Mounting	IEC 60384-21/22	4.3 The capacitors may be mounted on printed-circuit boards or ceramic substrates	No visible damage
Visual inspection and dimension check		4.4 Any applicable method using $\times 10$ magnification	In accordance with specification
Capacitance		4.5.1 Class 2: $f = 1 \text{ KHz}$ for $C \leq 10 \mu\text{F}$, measuring at voltage $1 V_{\text{rms}}$ at 20°C $f = 120 \text{ Hz}$ for $C > 10 \mu\text{F}$, measuring at voltage $0.5 V_{\text{rms}}$ at 20°C	Within specified tolerance
Dissipation factor (D.F.)		4.5.2 Class 2: $f = 1 \text{ KHz}$ for $C \leq 10 \mu\text{F}$, measuring at voltage $1 V_{\text{rms}}$ at 20°C $f = 120 \text{ Hz}$ for $C > 10 \mu\text{F}$, measuring at voltage $0.5 V_{\text{rms}}$ at 20°C	In accordance with specification
Insulation resistance		4.5.3 At U_r (DC) for 1 minute	In accordance with specification
Temperature characteristic		4.6 Class 2: Between minimum and maximum temperature X5R: -55°C to $+85^\circ\text{C}$ Normal Temperature: 20°C	<General purpose series> $\Delta C/C$ Class 2: X5R: $\pm 15\%$ <High Capacitance series> $\Delta C/C$ Class 2: X5R: $\pm 15\%$
Adhesion		4.7 A force applied for 10 seconds to the line joining the terminations and in a plane parallel to the substrate	Force size ≥ 0603 : 5N size = 0402: 2.5N size = 0201: 1N

TEST	TEST METHOD	PROCEDURE	REQUIREMENTS
Bond strength of plating on end face	IEC 60384-21/22	4.8 Mounting in accordance with IEC 60384-22 paragraph 4.3	No visible damage
		Conditions: bending 1 mm at a rate of 1 mm/s, radius jig 340 mm	<p><General purpose series></p> <p>$\Delta C/C$</p> <p>Class2:</p> <p>X5R: $\pm 10\%$</p> <p><High Capacitance series></p> <p>$\Delta C/C$</p> <p>Class2:</p> <p>X5R: $\pm 10\%$</p>
Resistance to soldering heat	4.9	Precondition: 150 ± 10 °C for 1 hour, then keep for 24 ± 1 hours at room temperature	Dissolution of the end face plating shall not exceed 25% of the length of the edge concerned
		Preheating: for size ≤ 1206 : 120 °C to 150 °C for 1 minute Preheating: for size >1206 : 100 °C to 120 °C for 1 minute and 170 °C to 200 °C for 1 minute Solder bath temperature: 260 ± 5 °C Dipping time: 10 ± 0.5 seconds Recovery time: 24 ± 2 hours	
			<p><General purpose series></p> <p>$\Delta C/C$</p> <p>Class2:</p> <p>X5R: $\pm 10\%$</p> <p><High Capacitance series></p> <p>$\Delta C/C$</p> <p>Class2:</p> <p>X5R: $\pm 10\%$</p>
			<p>D.F. within initial specified value</p> <p>R_{ns} within initial specified value</p>
Solderability	4.10	Preheated the temperature of 80 °C to 140 °C and maintained for 30 seconds to 60 seconds. Test conditions for lead containing solder alloy Temperature: 235 ± 5 °C Dipping time: 2 ± 0.2 seconds Depth of immersion: 10 mm Alloy Composition: 60/40 Sn/Pb Number of immersions: 1 Test conditions for leadfree containing solder alloy Temperature: 245 ± 5 °C Dipping time: 3 ± 0.3 seconds Depth of immersion: 10 mm Alloy Composition: SAC305 Number of immersions: 1	The solder should cover over 95% of the critical area of each termination

TEST	TEST METHOD	PROCEDURE	REQUIREMENTS
Rapid change of temperature	IEC 60384-21/22	4.11 Preconditioning: 150 +0/-10 °C for 1 hour, then keep for 24 ±1 hours at room temperature 5 cycles with following detail: 30 minutes at lower category temperature 30 minutes at upper category temperature Recovery time 24 ±2 hours	No visual damage <hr/> <General purpose series> ΔC/C Class2: X5R: ±15% <High Capacitance series> ΔC/C Class2: X5R: ±15% <hr/> D.F. meet initial specified value R _{ins} meet initial specified value
Damp heat with U _r load	4.13	1. Preconditioning, class 2 only: 150 +0/-10 °C /1 hour, then keep for 24 ±1 hour at room temp 2. Initial measure: Spec: refer initial spec C, D, IR 3. Damp heat test: 500 ±12 hours at 40 ±2 °C; 90 to 95% R.H. 1.0 U _r applied 4. Recovery: Class 2: 24 ±2 hours 5. Final measure: C, D, IR P.S. If the capacitance value is less than the minimum value permitted, then after the other measurements have been made the capacitor shall be precondition according to "IEC 60384 4.1" and then the requirement shall be met.	No visual damage after recovery <hr/> <General purpose series> ΔC/C Class2: X5R: ±15% D.F. Class2: X5R: ≤ 16V: ≤ 7% ≥ 25V: ≤ 5% R _{ins} Class2: X5R: ≥ 500 MΩ or R _{ins} × C _r ≥ 25s whichever is less <High Capacitance series> ΔC/C Class2: X5R: ±20% D.F. Class2: X5R: 2 × initial value max R _{ins} Class2: X5R: 500 MΩ or R _{ins} × C _r ≥ 25s whichever is less

TEST	TEST METHOD	PROCEDURE	REQUIREMENTS
Endurance	IEC 60384-21/22 4.14	1. Preconditioning, class 2 only: 150 +0/-10 °C /1 hour, then keep for 24 ±1 hour at room temp 2. Initial measure: Spec: refer initial spec C, D, IR 3. Endurance test: Temperature: X5R: 85 °C Specified stress voltage applied for 1,000 hours: Applied 2.0 × U _r for general product. Applied 1.5 × U _r for high cap. product. 4. Recovery time: 24 ±2 hours 5. Final measure: C, D, IR P.S. If the capacitance value is less than the minimum value permitted, then after the other measurements have been made the capacitor shall be precondition according to "IEC 60384 4.1" and then the requirement shall be met.	No visual damage <hr/> <General purpose series> ΔC/C Class2: X5R: ±15% D.F. Class2: X5R: ≤ 16V: ≤ 7% ≥ 25V: ≤ 5% R _{ins} Class2: X5R: ≥ 1,000 MΩ or R _{ins} × C _r ≥ 50s whichever is less <High Capacitance series> ΔC/C Class 2: X5R: ±20% D.F. Class 2: X5R: 2 × initial value max R _{ins} Class 2: X5R: 1,000 MΩ or R _{ins} × C _r ≥ 50s whichever is less
		Specified stress voltage applied for 1 minute U _r ≤ 100 V: series applied 2.5 U _r 100 V < U _r ≤ 200 V series applied (1.5 U _r + 100) 200 V < U _r ≤ 500 V series applied (1.3 U _r + 100) U _r > 500 V: 1.3 U _r I: 7.5 mA	No breakdown or flashover

REVISION HISTORY

REVISION	DATE	CHANGE NOTIFICATION	DESCRIPTION
Version 3	Oct 27, 2009	-	- Dimension updated
Version 2	Jun 09, 2009	-	- Ordering code updated
Version 1	May 15, 2009	-	- Product range updated
Version 0	Apr 15, 2009	-	<ul style="list-style-type: none"> - New datasheet for general purpose and high capacitance X5R series with RoHS compliant - Replace the "6.3V to 50V" part of pdf files: UP-X5R_X7R_HighCaps_6.3-to-25V_1 I, UY-X5R_X7R_HighCaps_6.3-to-25V_1 I - Combine 020I from pdf files: UP-NP0X5RX7RY5V_020I_6.3-to-50V_2 and UY-NPOX5RX7RY5V_020I_6.3-to-50V_2 - Define global part number - Description of "Halogen Free compliant" added - Test method and procedure updated